

# 1999 Bayou 300 4X4

## PARTS DIAGRAM

### Headlight(s)

F2710

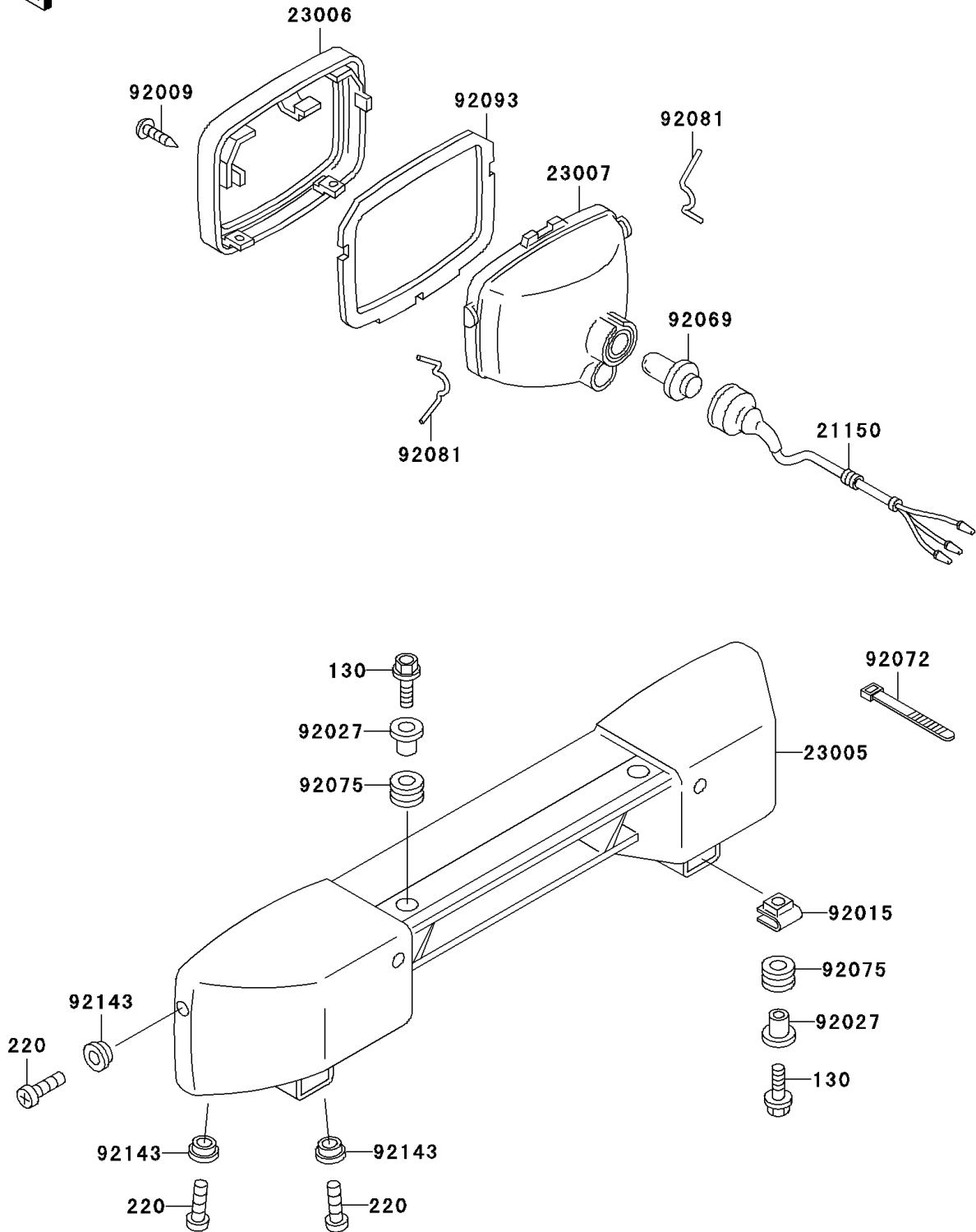

# 1999 Bayou 300 4X4

## PARTS LIST

Headlight(s)

**ITEM NAME**

**PART NUMBER**

**QUANTITY**

---