

1995 KLR650

PARTS DIAGRAM

Muffler(s)

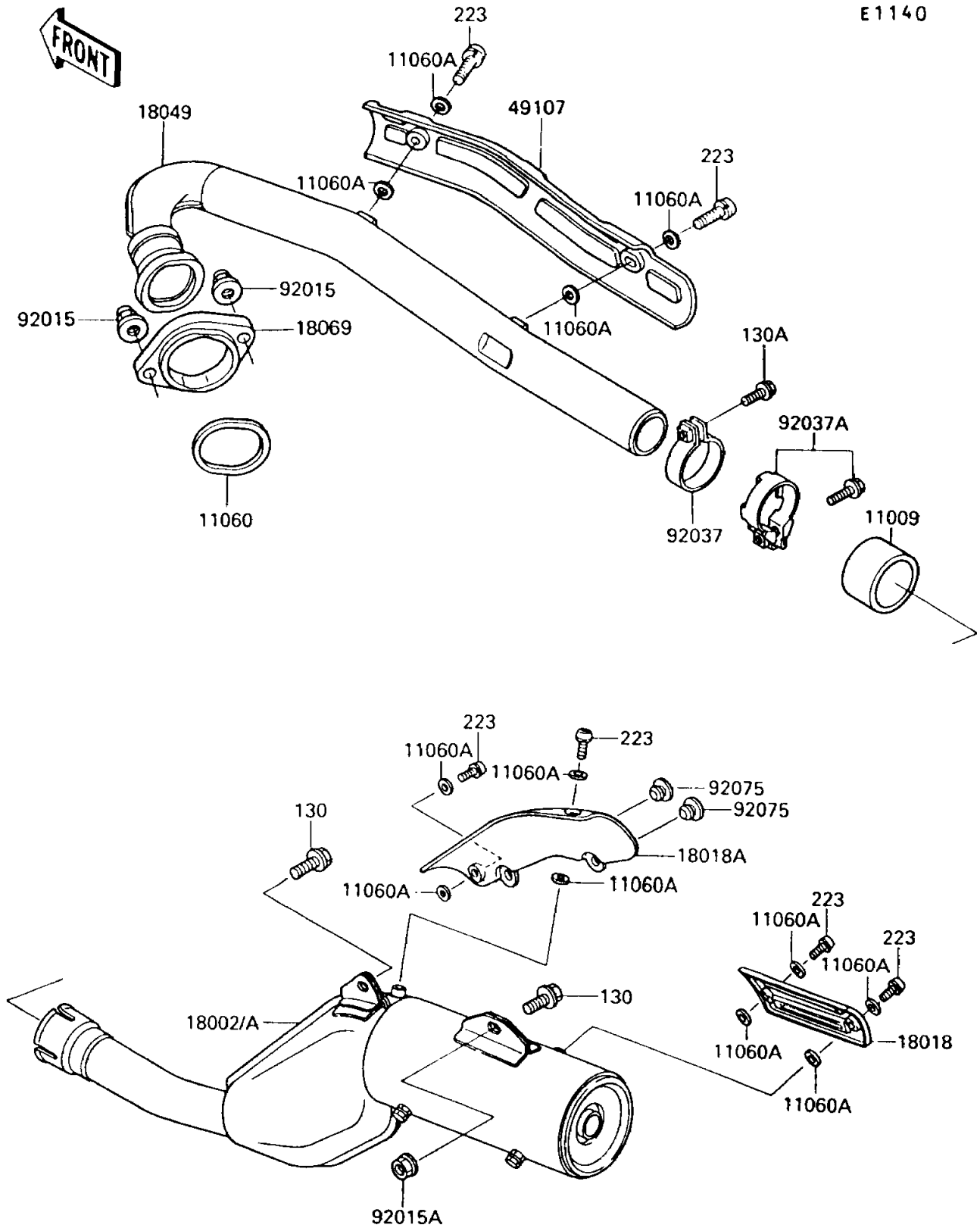

1995 KLR650

PARTS LIST

Muffler(s)

ITEM NAME	PART NUMBER	QUANTITY
GASKET,EXHAUST PIPE CONNECTING (Ref # 11009)	11009-1666	1
GASKET,EXHAUST PIPE HOLDER (Ref # 11060)	11060-1108	1
GASKET,6.2X11.5X1.5 (Ref # 11060A)	11060-1109	12
BODY-COMP-MUFFLER (Ref # 18002)	18002-1886	1
BODY-COMP-MUFFLER (Ref # 18002A)	18002-1887	1
PLATE-HEAT GUARD (Ref # 18018)	18018-1053	1
PLATE-HEAT GUARD (Ref # 18018A)	18018-1072	1
PIPE-EXHAUST (Ref # 18049)	18049-1460	1
HOLDER-EXHAUST PIPE (Ref # 18069)	18069-1063	1
COVER-EXHAUST PIPE,FR (Ref # 49107)	49107-1073	1
NUT,CAP,8MM,BLACK (Ref # 92015)	92015-1174	2
NUT,8MM (Ref # 92015A)	92015-1402	1
CLAMP,43MM (Ref # 92037)	92037-1888	1
CLAMP (Ref # 92037A)	92037-1910	1
DAMPER (Ref # 92075)	92075-005	2
BOLT-FLANGED,8X16,BLACK (Ref # 130)	130J0816	2
BOLT-FLANGED,8X20 (Ref # 130A)	130J0820	1
SCREW-PAN-WS-CROS (Ref # 223)	223C0610	6