

1996 Lakota 300

PARTS DIAGRAM

Ignition Switch



27008D

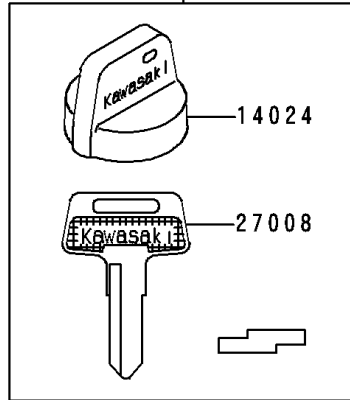

27008E

F2770

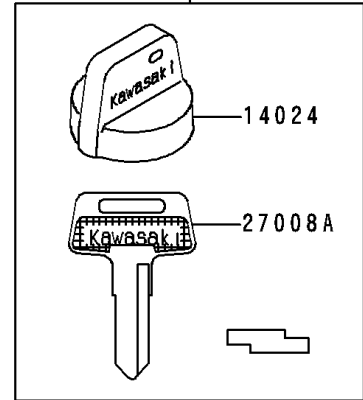

27008F

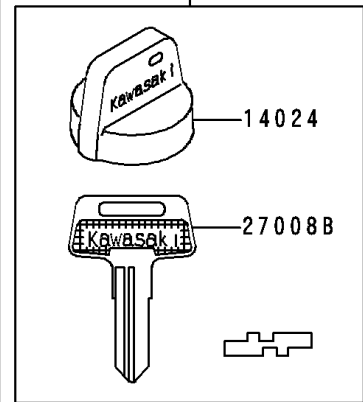

27008G

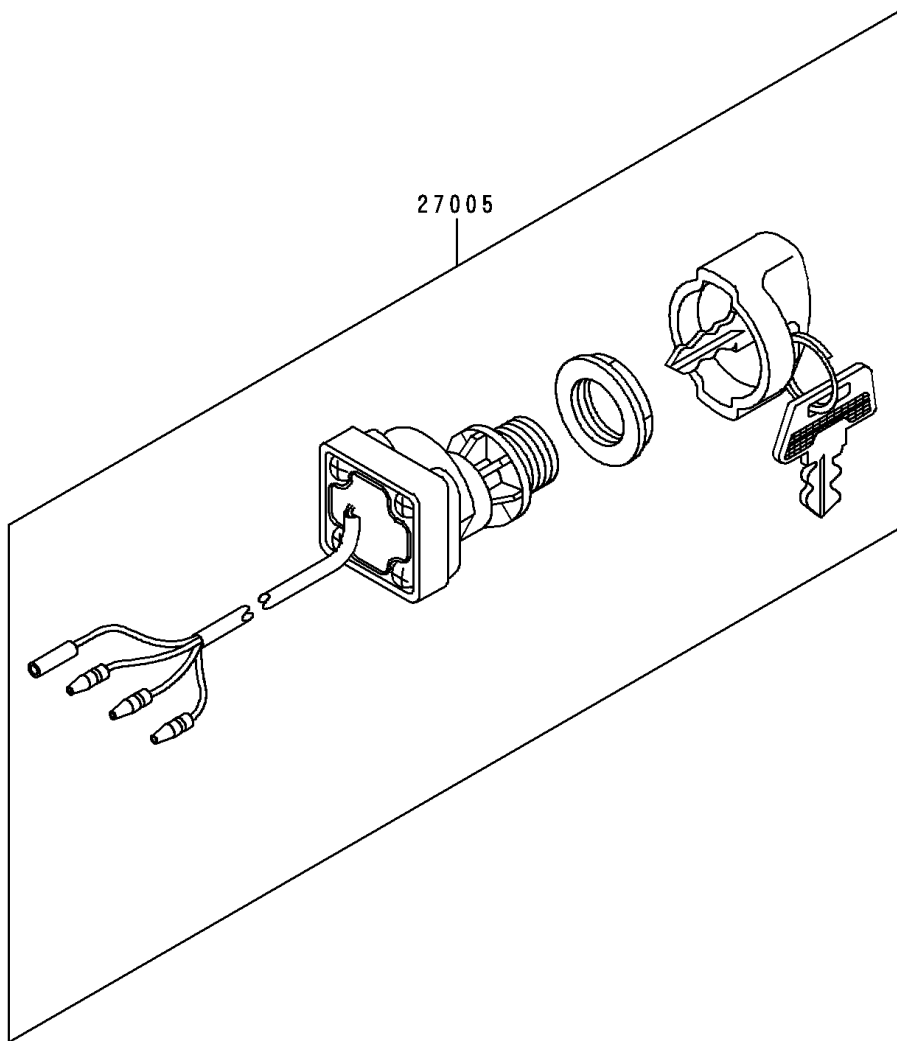
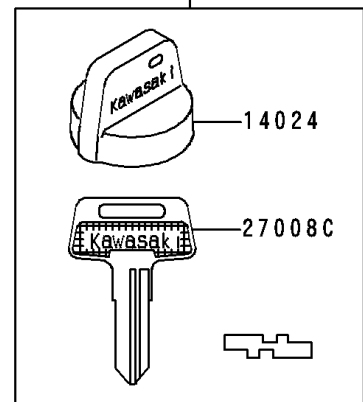

27005

1996 Lakota 300

PARTS LIST

Ignition Switch

ITEM NAME

PART NUMBER

QUANTITY
