

1999 Lakota 300

PARTS DIAGRAM

Valve(s)

E1210

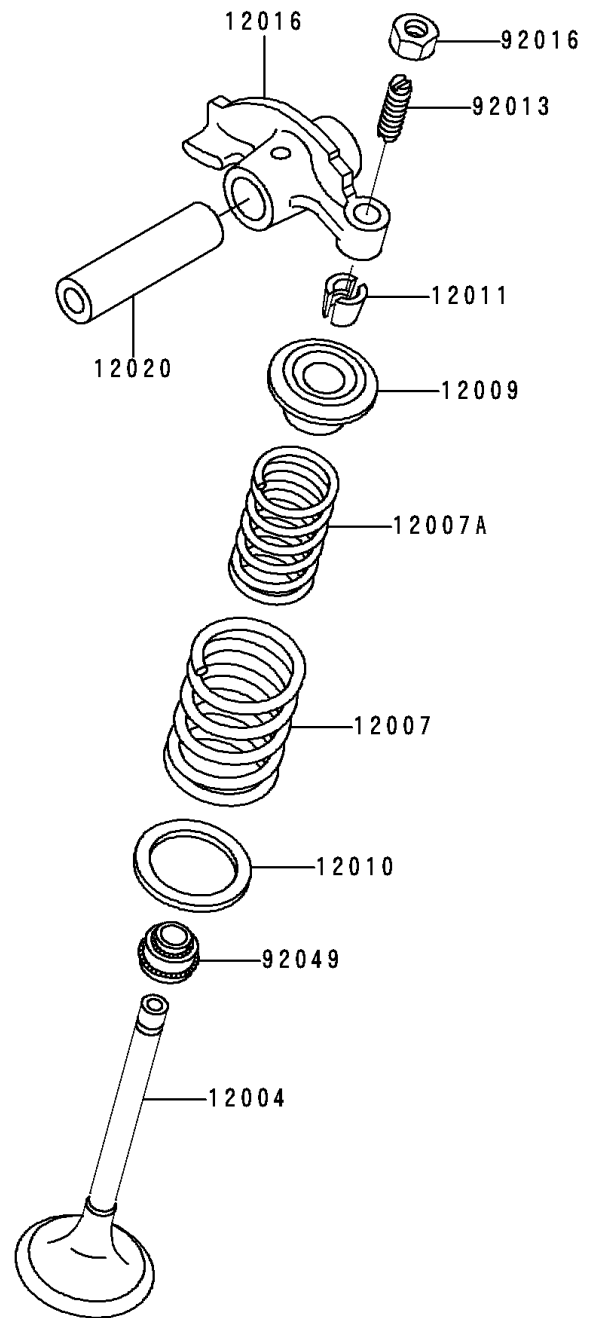
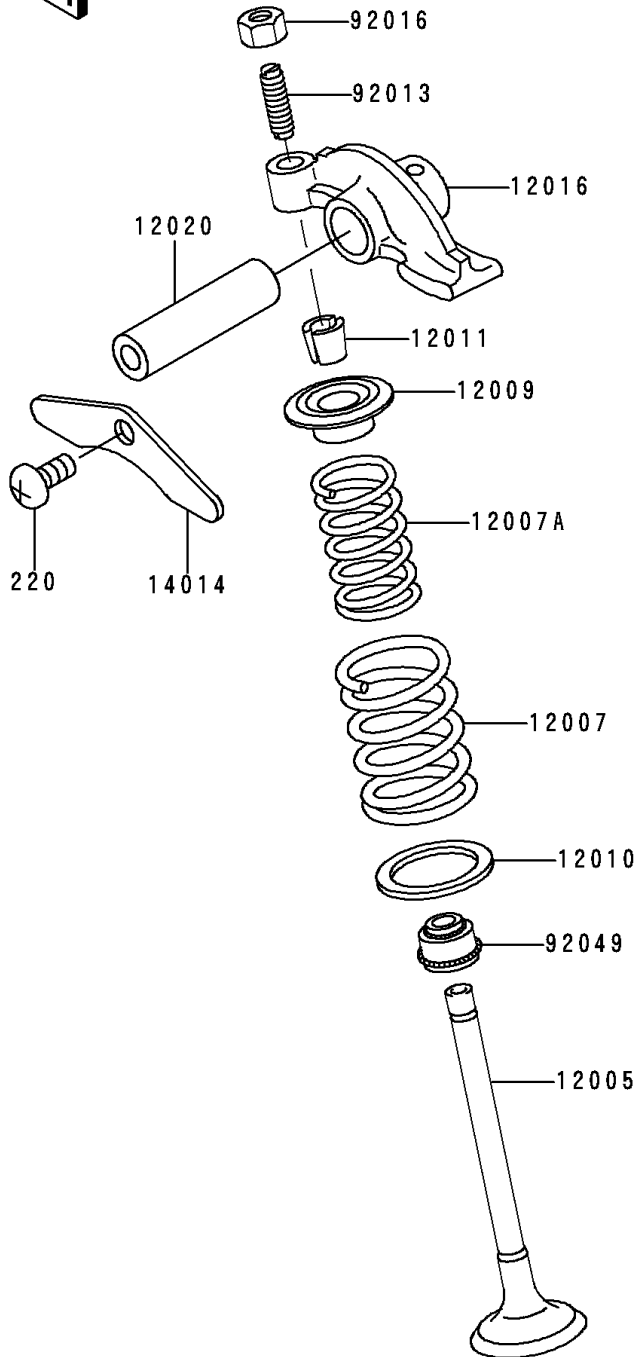

1999 Lakota 300

PARTS LIST

Valve(s)

ITEM NAME

PART NUMBER

QUANTITY
