

# 2000 KDX200

## PARTS DIAGRAM

Meter(s)

F2530

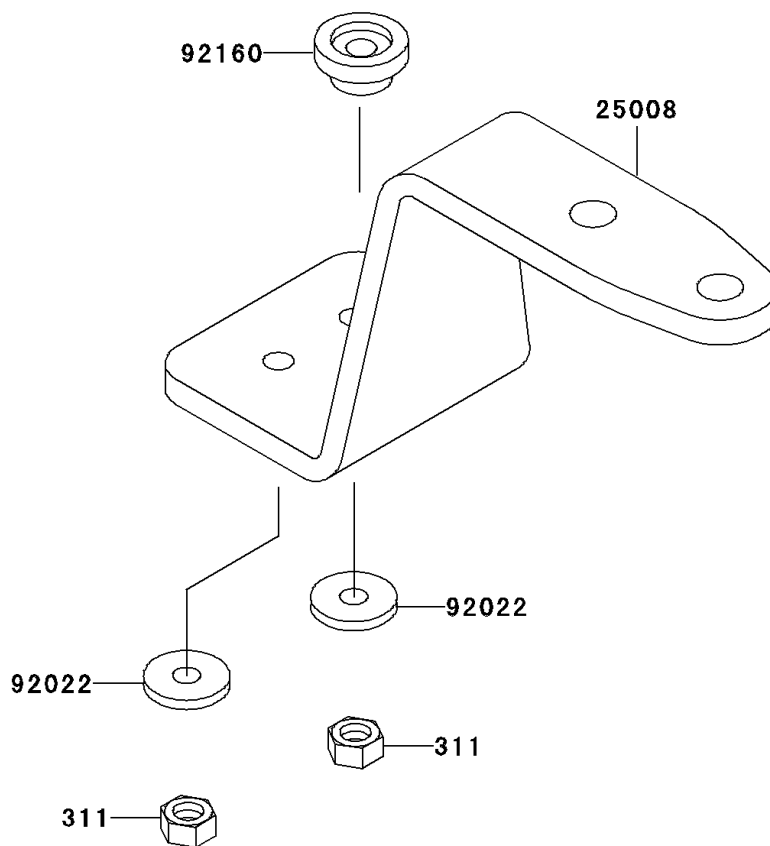
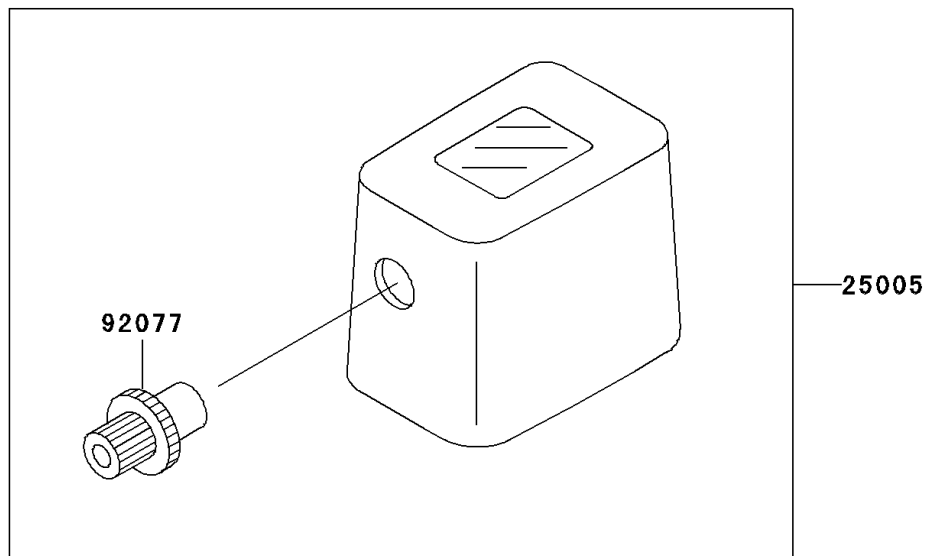

# 2000 KDX200

## PARTS LIST

Meter(s)

**ITEM NAME**

**PART NUMBER**

**QUANTITY**

---