

2004 900 STX

PARTS DIAGRAM

Crankcase

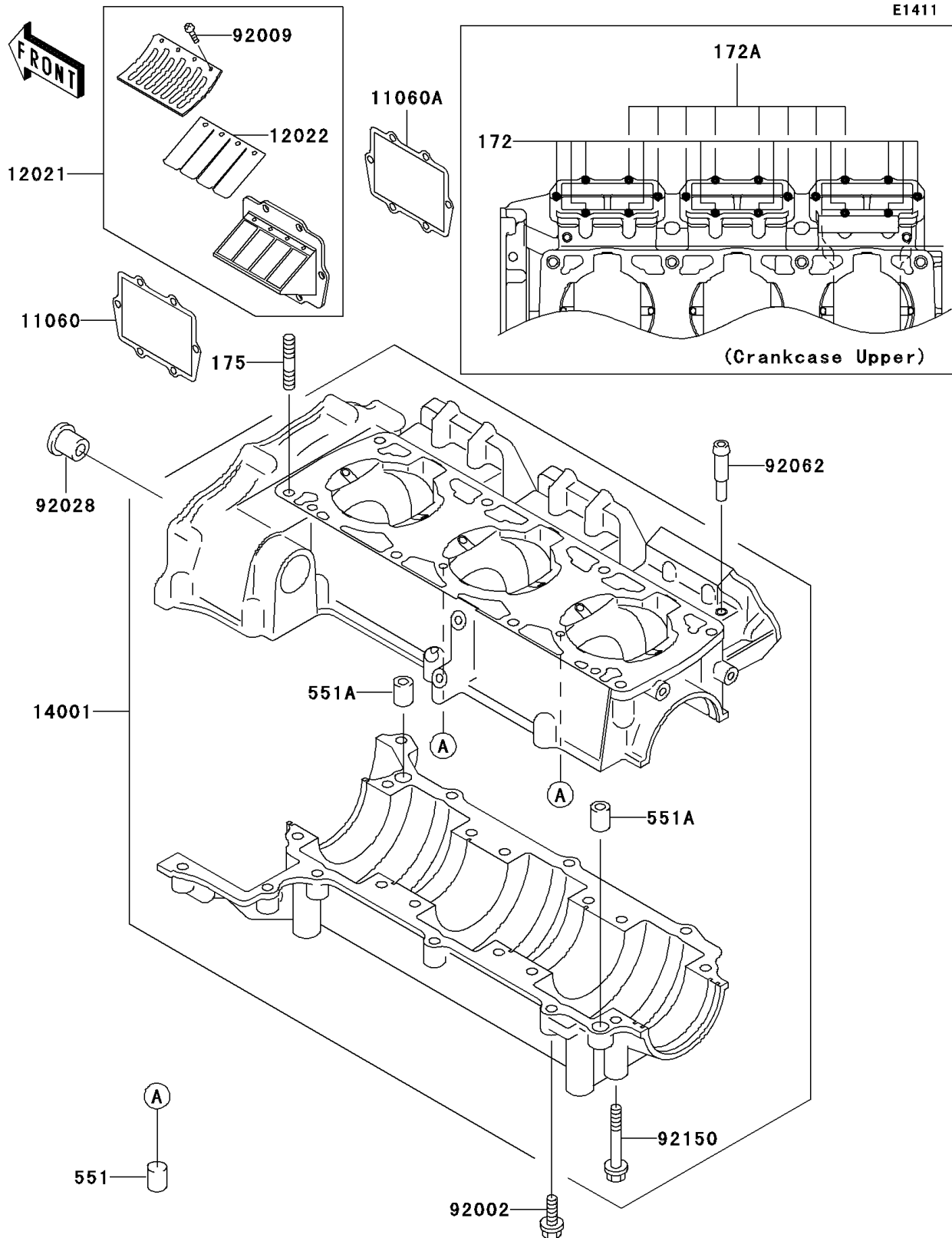

2004 900 STX

PARTS LIST

Crankcase

Kawasaki

Let the Good Times Roll®

ITEM NAME

PART NUMBER

QUANTITY
