

# 2015 NINJA® 650 ABS

## PARTS DIAGRAM

### Labels

F2860

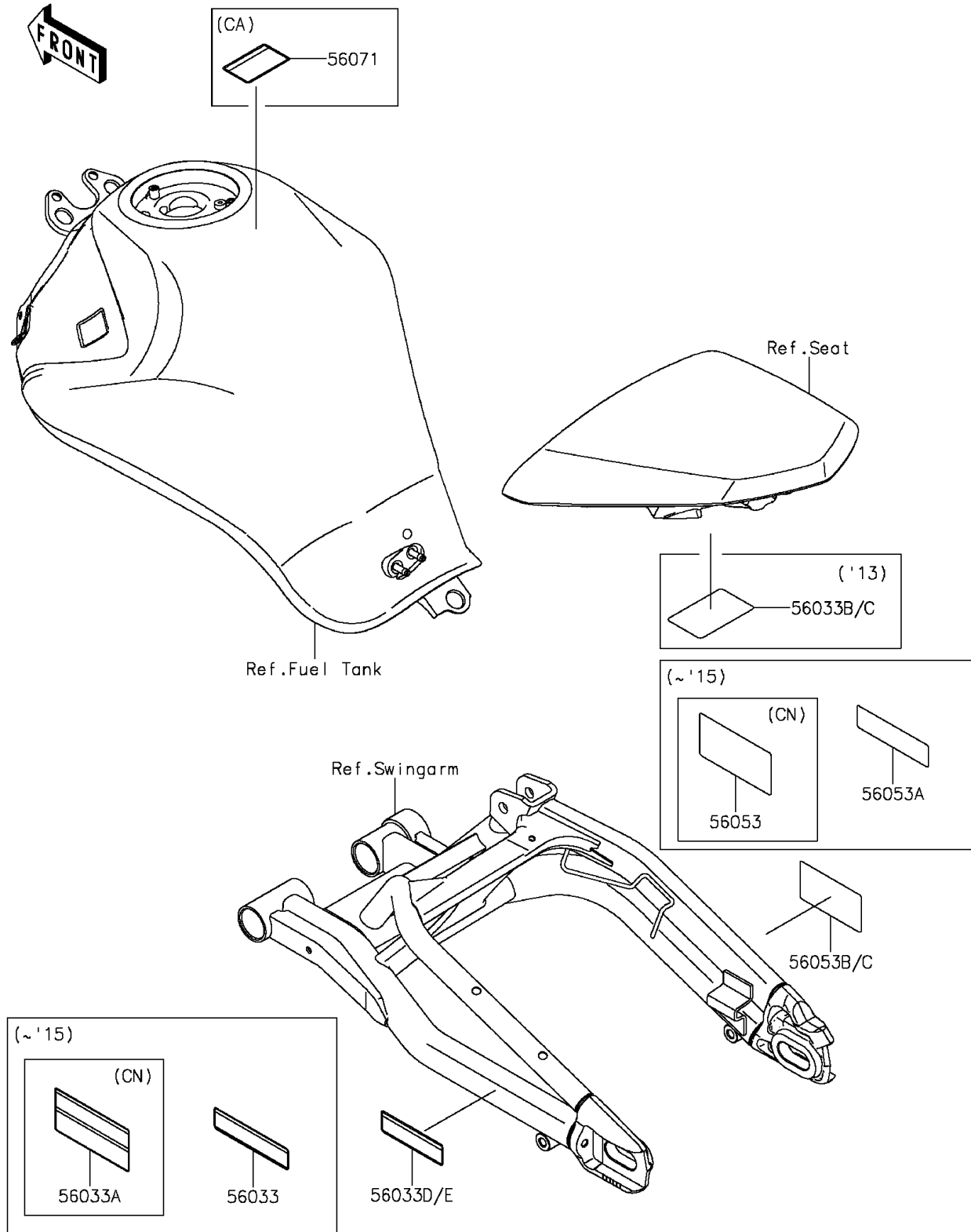

# 2015 NINJA® 650 ABS

## PARTS LIST

### Labels

**ITEM NAME**

**PART NUMBER**

**QUANTITY**

---