

2014 KLX450R (Australian)

PARTS DIAGRAM

Chassis Electrical Equipment

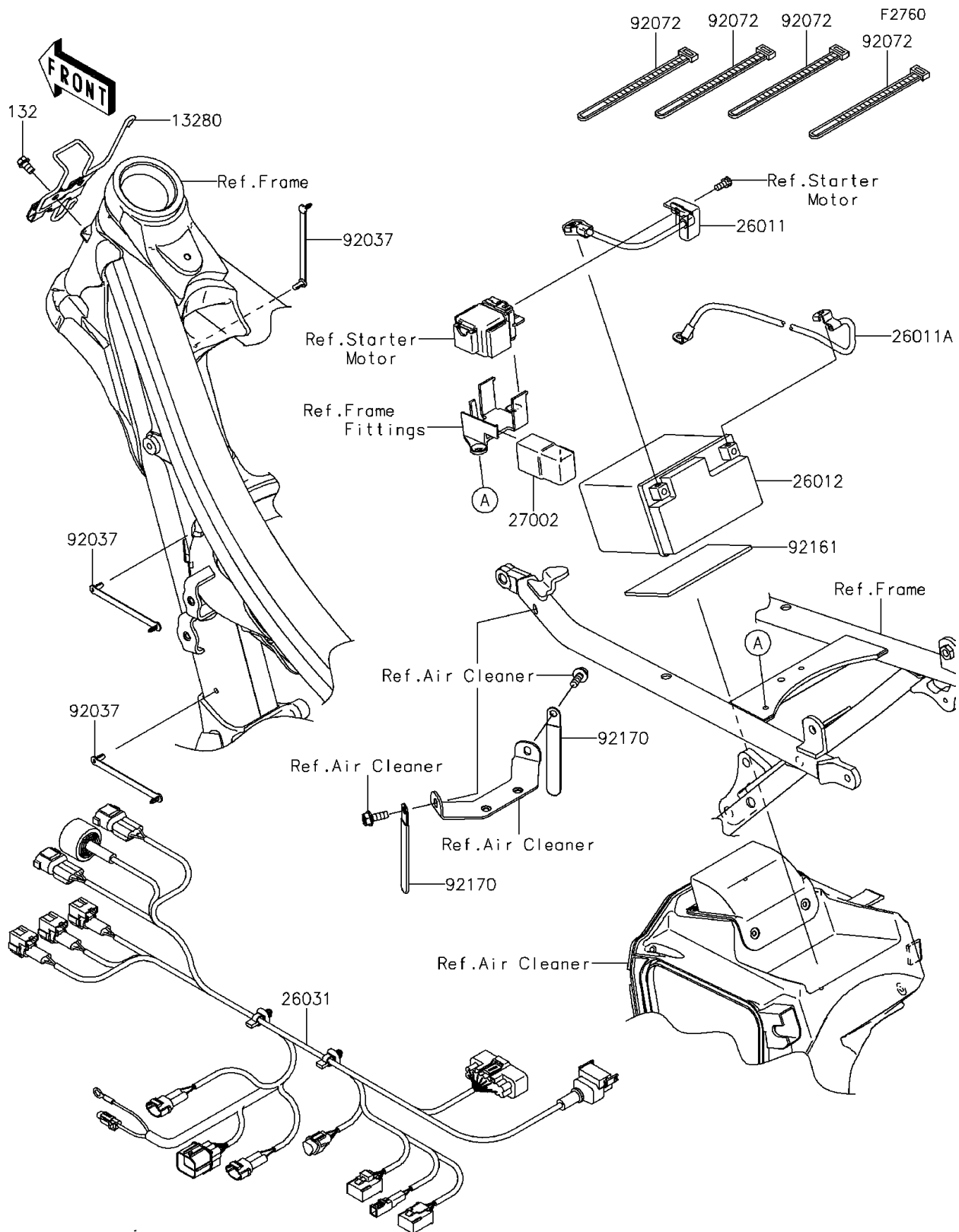

2014 KLX450R (Australian)

PARTS LIST

Chassis Electrical Equipment

ITEM NAME	PART NUMBER	QUANTITY
BOLT-FLANGED-SMALL,6X10 (Ref # 132)	132BA0610	2
HOLDER,CONNECTOR&CABLE (Ref # 13280)	13280-0214	1
WIRE-LEAD,BATTERY(+) (Ref # 26011)	26011-0131	1
WIRE-LEAD,BATTERY(-) (Ref # 26011A)	26011-0132	1
BATTERY,YTZ7S(F),12V 6AH (Ref # 26012)	26012-0563	1
HARNESS,MAIN (Ref # 26031)	26031-0601	1
RELAY-ASSY (Ref # 27002)	27002-1086	1
CLAMP,SPEED,L=80.5 (Ref # 92037)	92037-1903	3
BAND,L=140 (Ref # 92072)	92072-1293	4
DAMPER (Ref # 92161)	92161-0456	1
CLAMP (Ref # 92170)	92170-1925	2