

# 1999 KLR650

## PARTS DIAGRAM

### Front Brake

F2292

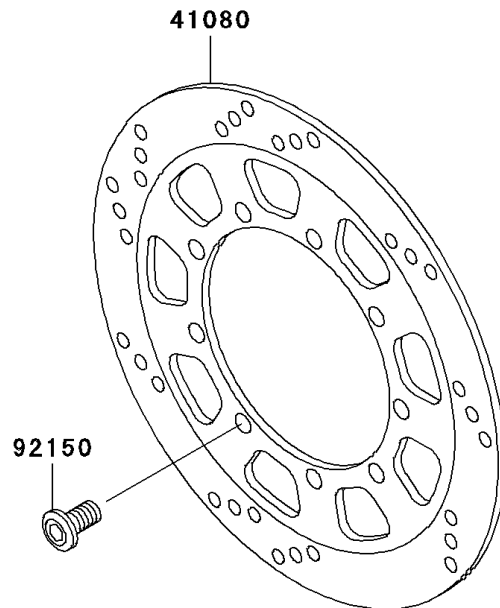
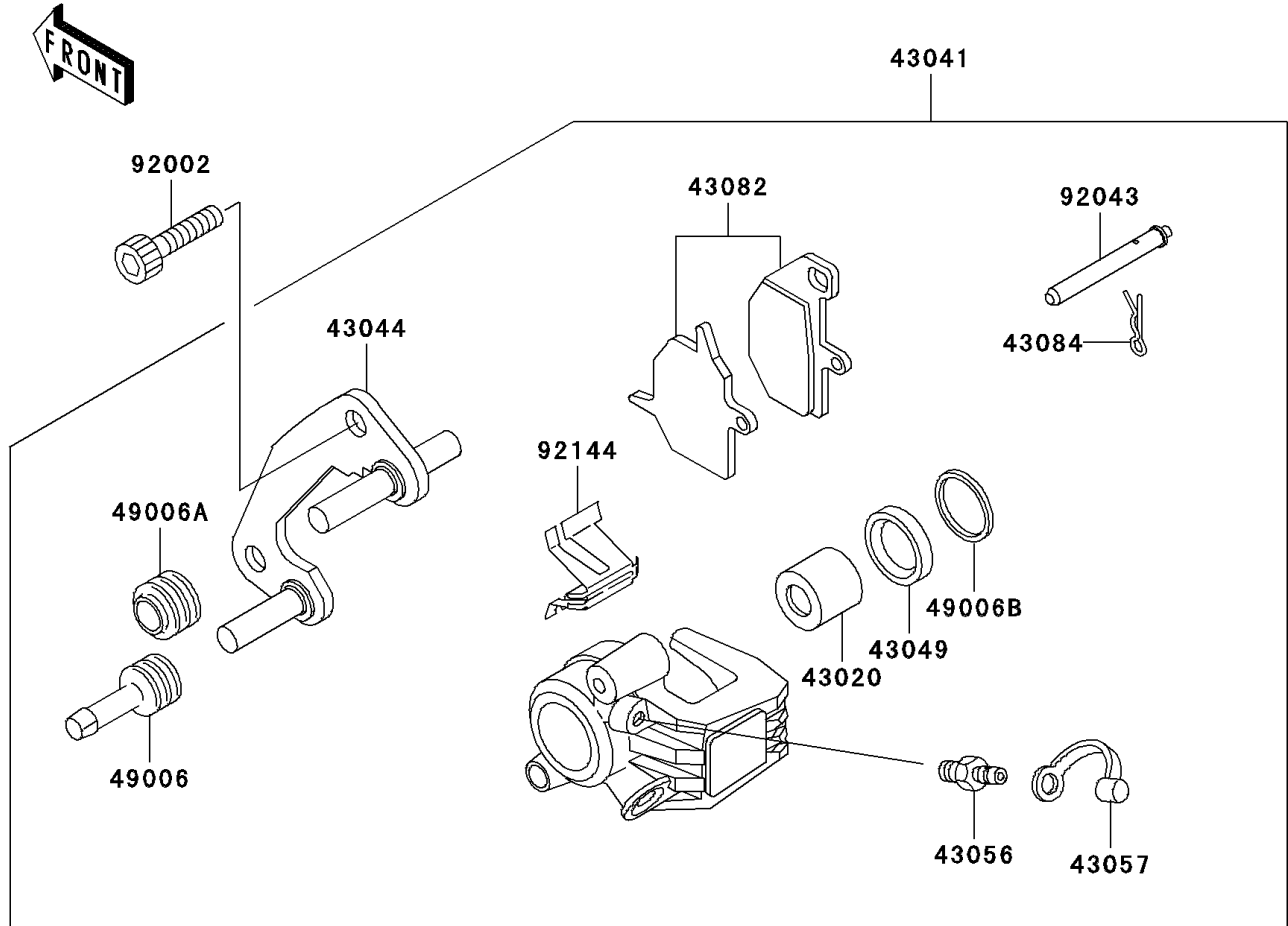

# 1999 KLR650

## PARTS LIST

### Front Brake

**ITEM NAME**

**PART NUMBER**

**QUANTITY**

---