

# 2000 KLR650

## PARTS DIAGRAM

### Shock Absorber(s)

F2280



45014

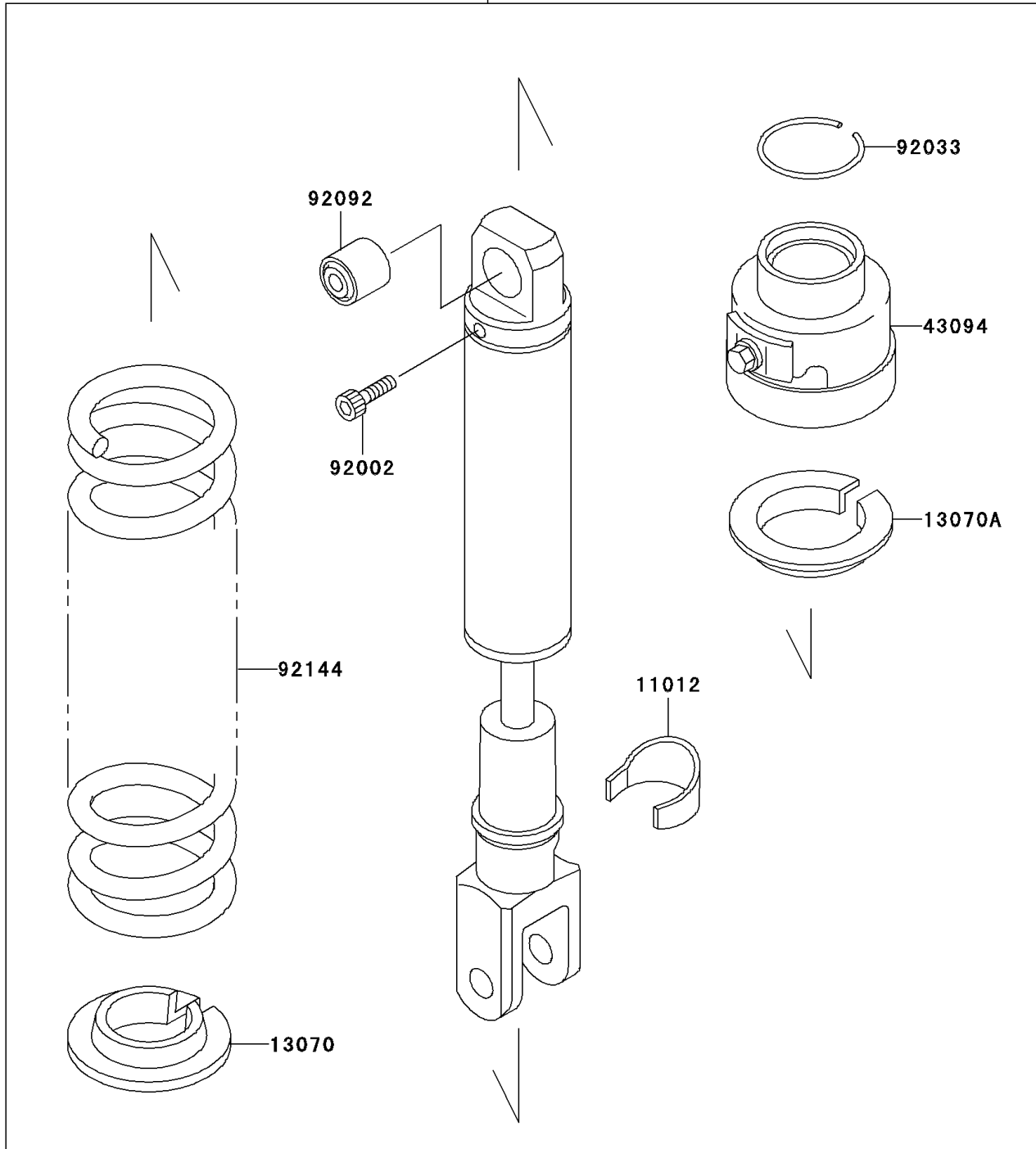

# 2000 KLR650

## PARTS LIST

### Shock Absorber(s)

**ITEM NAME**

**PART NUMBER**

**QUANTITY**

---