

# 2013 KLX<sup>®</sup>140

## PARTS DIAGRAM

### Cables

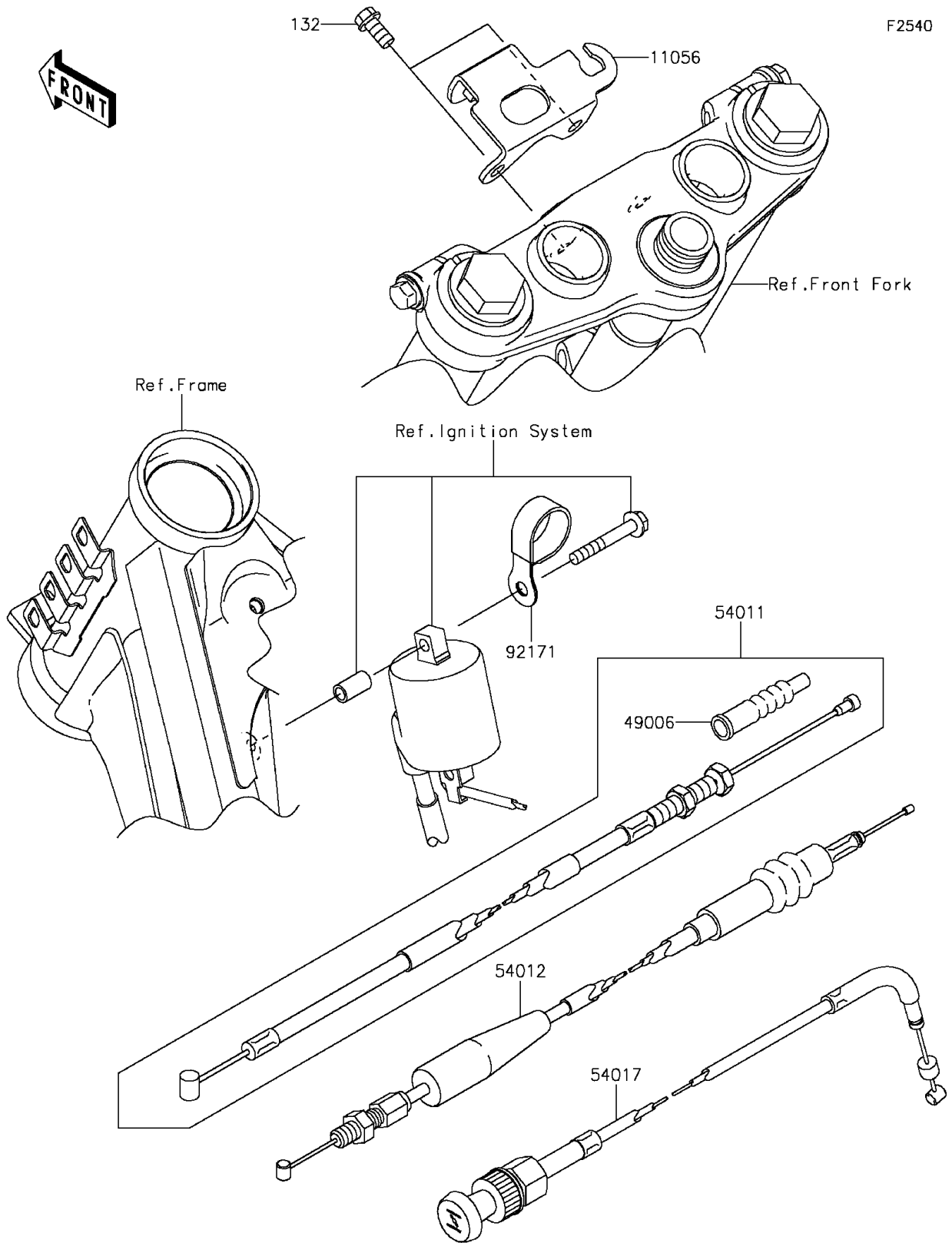

# 2013 KLX<sup>®</sup>140

## PARTS LIST

### Cables

**ITEM NAME**

**PART NUMBER**

**QUANTITY**

---