

1970 Bushwhacker

PARTS DIAGRAM

REAR HUB/BRAKE/CHAIN

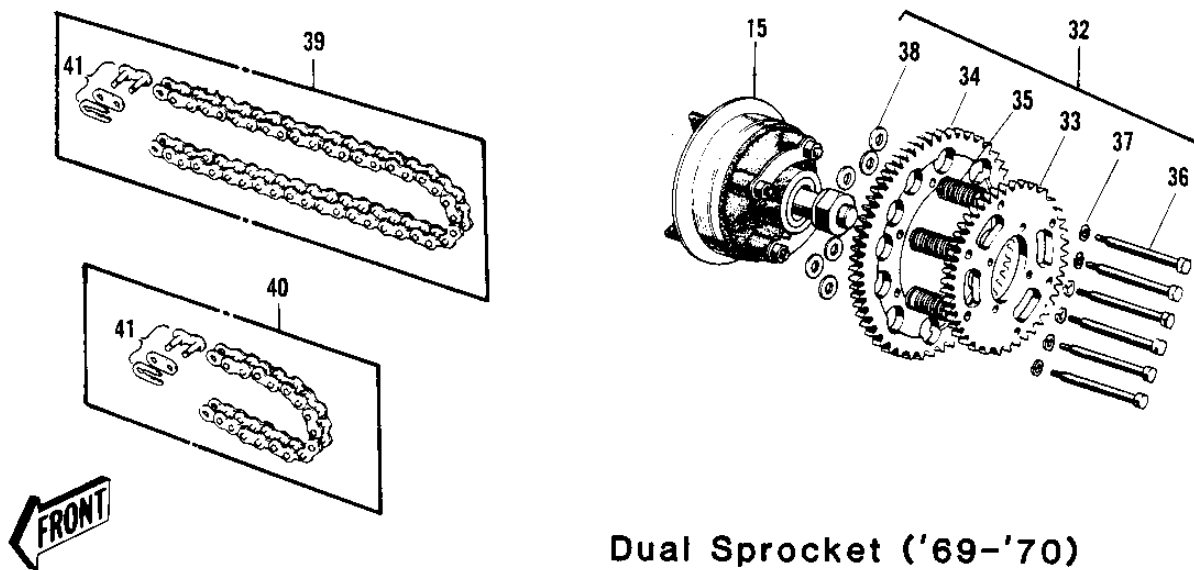
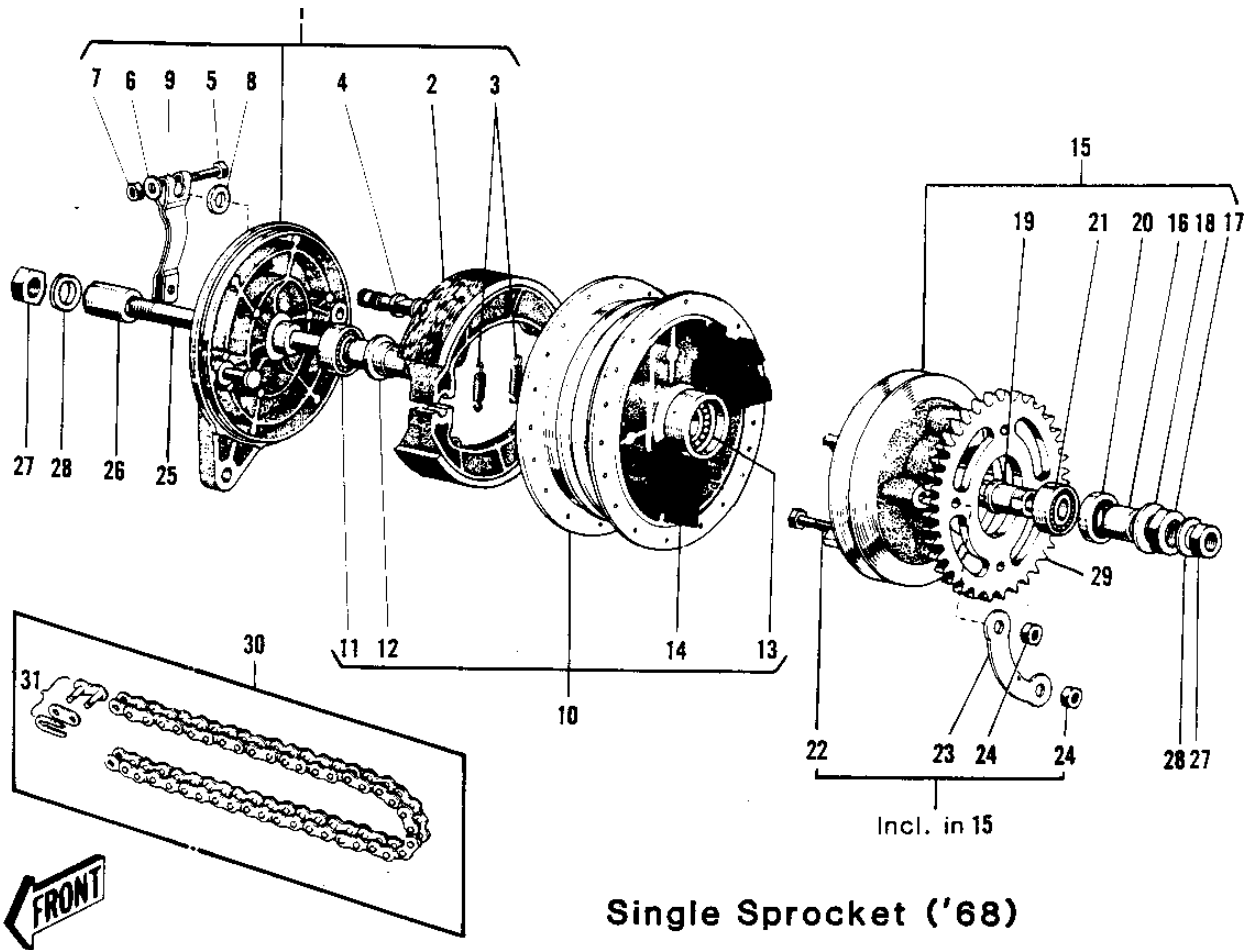

1970 Bushwhacker

PARTS LIST

REAR HUB/BRAKE/CHAIN

ITEM NAME	PART NUMBER	QUANTITY
PANEL-ASY,RR BRK (Ref # 1)	42006-080-80	
.SHOE,BRAKE (Ref # 2)	42019-011	
SHOE,BRAKE (Ref # 2)	42019-011	
.SPRING-BRAKE SHOE (Ref # 3)	42020-004	
.CAM SHAFT,REAR BRAKE (Ref # 4)	42026-021	
CAM SHAFT,REAR BRAKE (Ref # 4)	42026-021	
.BOLT 6X35 (Ref # 5)	110R0635	
.WASHER PLAIN 6MM (Ref # 6)	410B0600	
.NUT 6MM (Ref # 7)	311B0600	
.DUST SHIELD BRAKE CAM (Ref # 8)	41051-001	
.LEVER REAR BRAKE CAM (Ref # 9)	42029-003	
DRUM ASSY REAR BRAKE (Ref # 10)	42005-018	
.BEARING BALL #6202Z (Ref # 11)	601B6202Z	
.SPACER RR HUB BEARING (Ref # 12)	42010-004	
.BEARING BALL #6202 (Ref # 13)	601B6202	
.DAMPER REAR HUB SHOCK (Ref # 14)	42014-004	
COUPLING ASSY RR HUB (Ref # 15)	42008-009	
.BUSH RR DRUM OIL SEAL (Ref # 16)	42037-002	
.NUT,20MM (Ref # 17)	42045-015	
.WASHER PLAIN 22MM (Ref # 18)	42046-003	
.SLEEVE RR HUB COUPLNG (Ref # 19)	42036-001	
.OIL SEAL RR BRK DRUM (Ref # 20)	92050-009	
.BEARING BALL #6004 (Ref # 21)	601B6004	
.BOLT HEX HEAD 10X38 (Ref # 22)	113B1038	
.WASHER SPROCKET LOCK (Ref # 23)	92088-005	
.NUT,10MM (Ref # 24)	314B1000	
AXLE,REAR (Ref # 25)	42031-016	
COLLAR REAR HUB R.H (Ref # 26)	42032-004	
NUT,14MM (Ref # 27)	314B1400	

1970 Bushwhacker

PARTS LIST

REAR HUB/BRAKE/CHAIN

ITEM NAME	PART NUMBER	QUANTITY
UNAVAILABLE IN PRICE BOOK (Ref # 28)	42046-006	
WASHER PLAIN 14MM (Ref # 28)	411B1400	
REAR SPROCKET 39T (Ref # 29)	42041-040	
REAR SPROCKET 38T (Ref # 29)	42041-025	
REAR SPROCKET 42T (Ref # 29)	42041-005	
DR CHAIN 428X114H (Ref # 30)	92057-033	
.JOINT-CHAIN (Ref # 31)	92058-1015	
DUAL SPROCKET ASSY (Ref # 32)	42040-002	
REAR SPROCKET 44T (Ref # 33)	42041-014	
REAR SPROCKET 59T (Ref # 34)	42041-013	
SPRING REAR SPROCKET (Ref # 35)	42042-001	
BOLT SPROCKET (Ref # 36)	92001-083	
WASHER SPRING 8MM (Ref # 37)	461F0800	
WASHER REAR SPROCKET (Ref # 38)	92022-040	
DR CHAIN 428X118H (Ref # 39)	92057-030	
DR CHAIN 428X8H (Ref # 40)	695Z4308	
JOINT-CHAIN (Ref # 41)	92058-1015	