

1984 JS550

PARTS DIAGRAM

ELECTRIC CASE

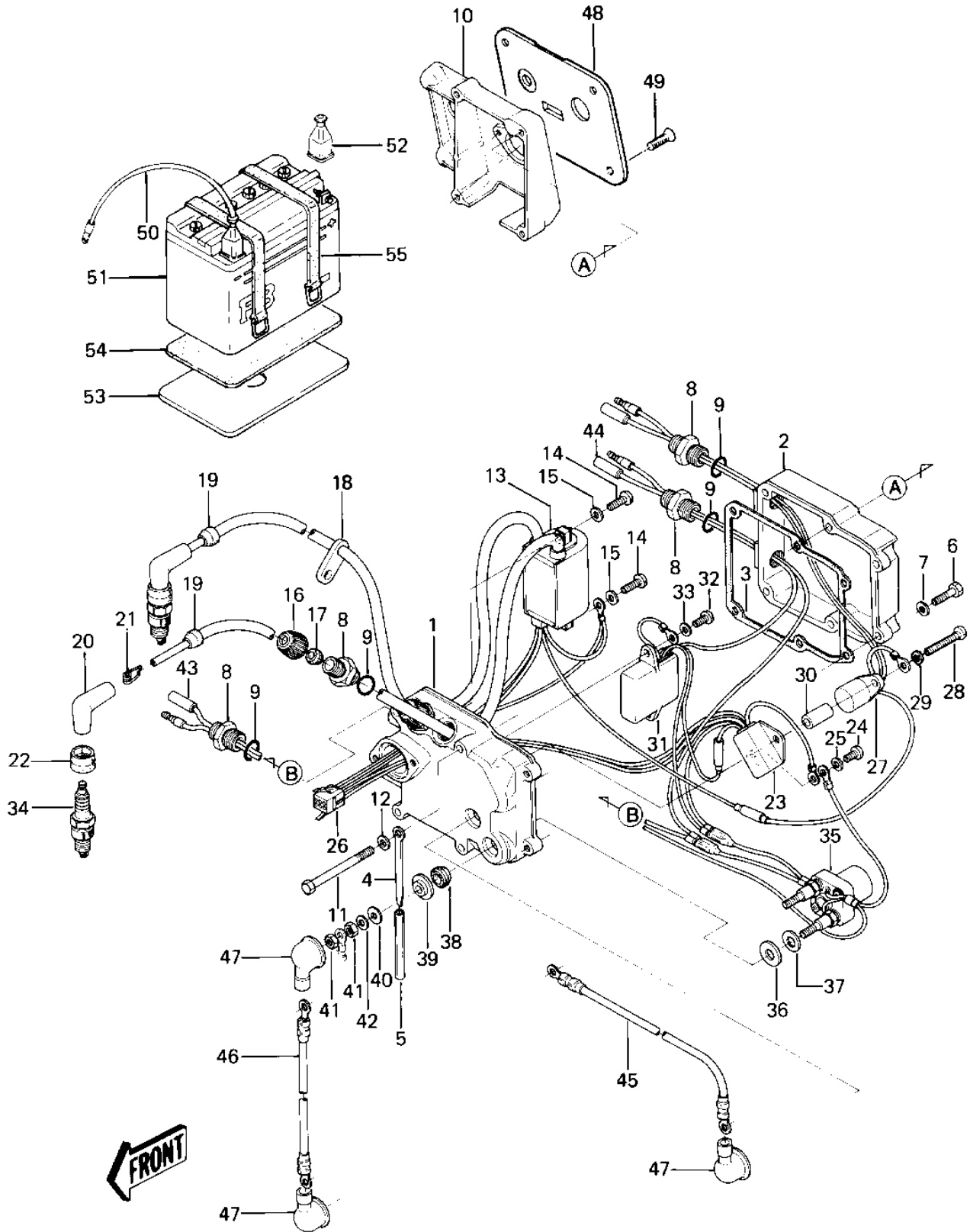

1984 JS550

PARTS LIST ELECTRIC CASE

ITEM NAME

PART NUMBER

QUANTITY
