

1970 Mach III

PARTS DIAGRAM

HEADLIGHT (H1-D/E/F)

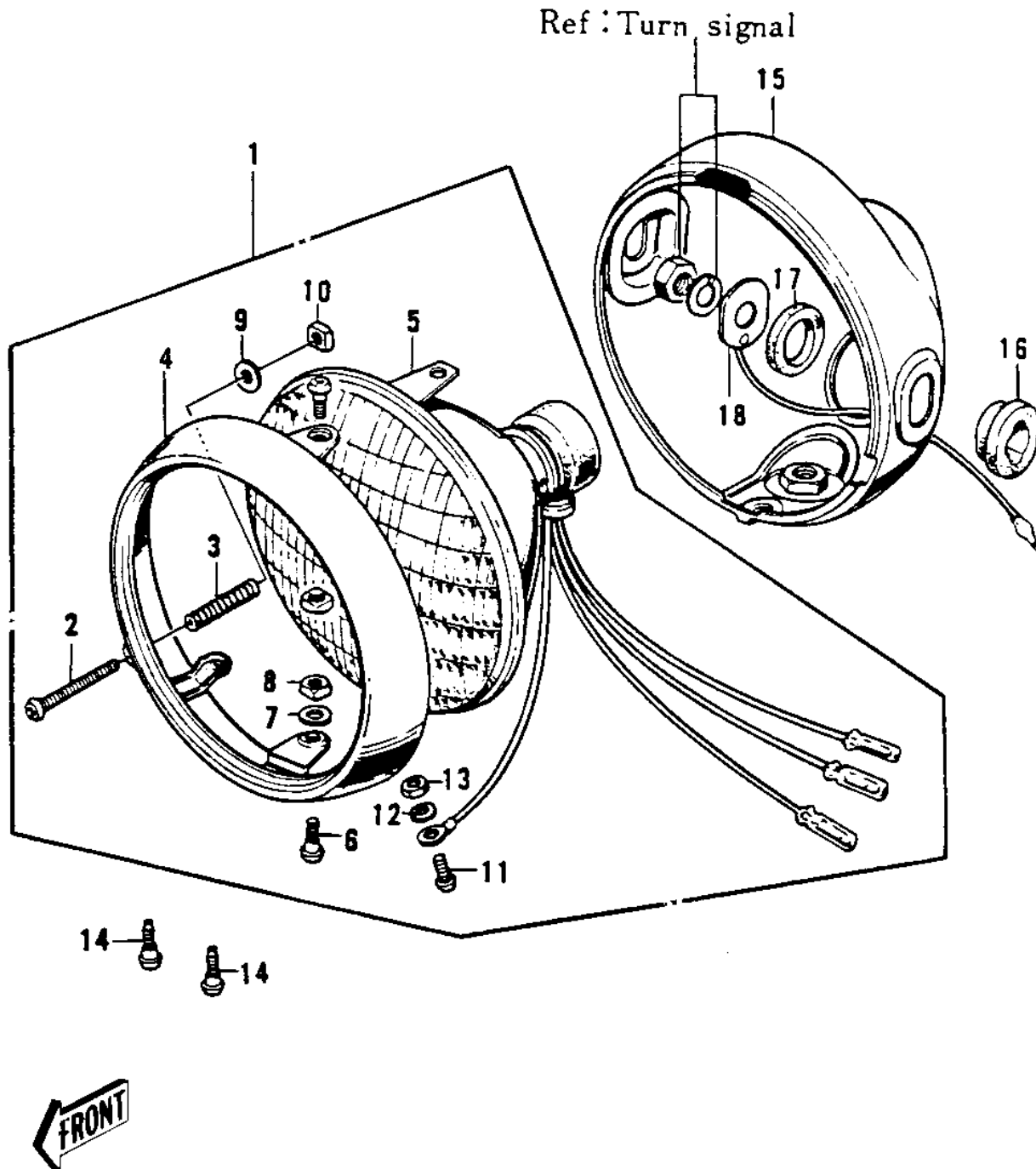

(H1-D/

1970 Mach III

PARTS LIST

HEADLIGHT (H1-D/E/F)

ITEM NAME	PART NUMBER	QUANTITY
LAMP UNIT-HEAD (Ref # 1)	23003-018	1
SCREW FORCUS ADJUST (Ref # 2)	23019-021	1
SPRING FOCUS ADJUST (Ref # 3)	23014-005	1
RIM-HEAD LAMP (Ref # 4)	23006-034	1
SEALED BEAM UNIT (Ref # 5)	23007-043	1
SCREW-PAN HEAD,5X12 (Ref # 6)	23019-023	2
WASHER-PLAIN,5MM (Ref # 7)	23021-012	2
NUT,HEAD LAMP RIM FIT (Ref # 8)	23020-023	2
WASHER (Ref # 9)	23021-004	1
NUT,4MM (Ref # 10)	23020-018	1
SCREW-PAN-HEAD 3X6 (Ref # 11)	220B0306	1
WASHER SPRING 3MM (Ref # 12)	461F0300	1
NUT-HEX (Ref # 13)	311B0300	1
SCREW,PAN HEAD,5X14 (Ref # 14)	23019-022	1
BODY-HEAD.LAMP,BLACK (Ref # 15)	23005-038-21	1
DAMPER RUBBER A (Ref # 16)	23066-001	2
DAMPER RUBBER (Ref # 17)	23066-005	2
COLLAR (Ref # 18)	23076-005	2