

1982 CSR

PARTS DIAGRAM

REAR HUB/CHAIN

F2240-0017

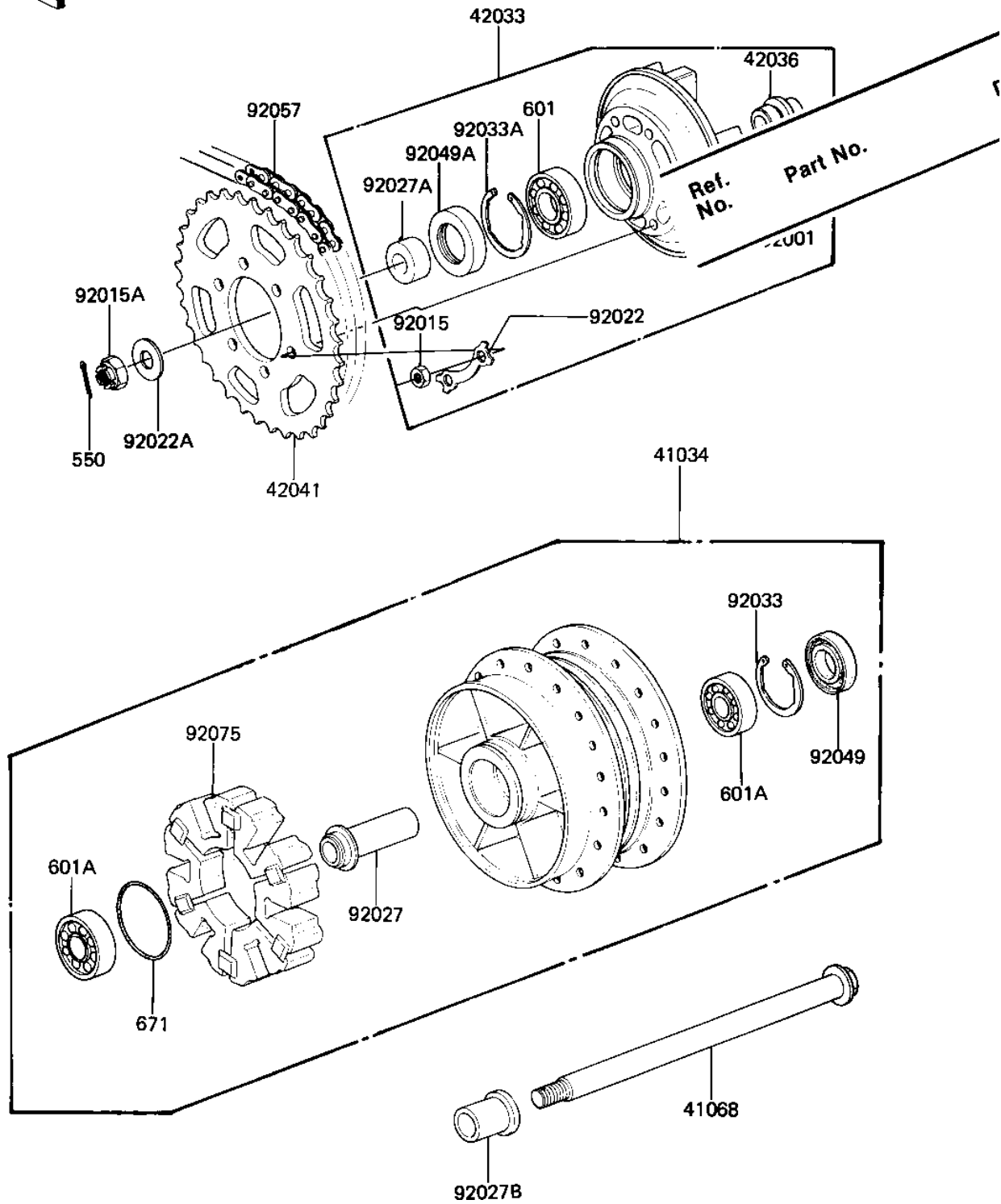

1982 CSR

PARTS LIST

REAR HUB/CHAIN

ITEM NAME	PART NUMBER	QUANTITY
DRUM-ASSY,RR BRK (Ref # 41034)	41034-1031	1
AXLE,RR,L=300 (Ref # 41068)	41068-1087	1
COUPLING-ASSY (Ref # 42033)	42033-1024	1
SLEEVE,L=33 (Ref # 42036)	42036-1039	1
SPROCKET-HUB,39T (Ref # 42041)	42041-1059	1
BOLT (Ref # 92001)	92001-161	6
NUT 10MM (Ref # 92015)	42045-005	6
NUT CASTLE,18MM (Ref # 92015A)	42045-018	1
WASHER,LOCK (Ref # 92022)	92022-1212	3
WASHER,PLAIN,20MM (Ref # 92022A)	92022-248	1
COLLAR,L=89.5 (Ref # 92027)	92027-1286	1
COLLAR,20X40X18 (Ref # 92027A)	92027-1287	1
COLLAR,L=31 (Ref # 92027B)	92027-1288	1
RING,SNAP,56.2M/M (Ref # 92033)	92033-1043	1
CIRCLIP,62M/M (Ref # 92033A)	92033-1044	1
SEAL-OIL (Ref # 92049)	92049-1061	1
OIL SEAL (Ref # 92049A)	92050-027	1
DR CHAIN 630X96 (Ref # 92057)	92057-1053	1
SHOCK DAMPER,REAR HUB (Ref # 92075)	42014-033	1
PIN-COTTER,4.0X35 (Ref # 550)	550D4035	1
BALL BEARING,#6206 (Ref # 601)	601B6206	1
BEARING,BALL,#6304ZZ (Ref # 601A)	601B6304ZZ	2
"0" RING,65MM (Ref # 671)	671B2565	1