

1997 1100 STX

PARTS DIAGRAM

Starter Motor

E1840

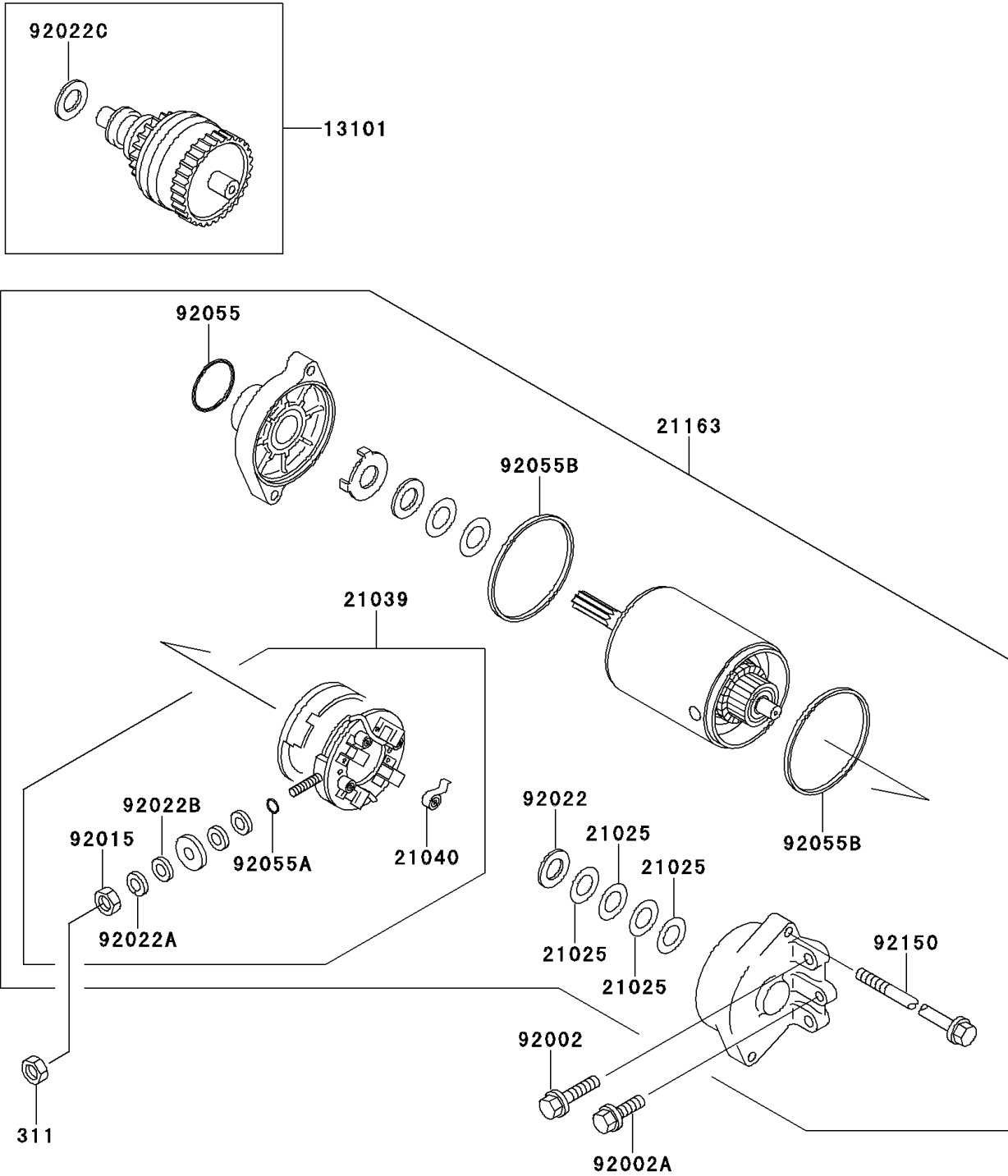

1997 1100 STX

PARTS LIST

Starter Motor

| ITEM NAME | PART NUMBER | QUANTITY |
|-------------------------------------|-------------|----------|
| NUT-HEX,6MM (Ref # 311) | 311R0600 | 1 |
| GEAR-ASSY (Ref # 13101) | 13101-3708 | 1 |
| WASHER,9.1X18X0.2 (Ref # 21025) | 21025-011 | 4 |
| BRUSH,CARBON (Ref # 21039) | 21039-3703 | 1 |
| SPRING-BRUSH (Ref # 21040) | 21040-1055 | 4 |
| STARTER-ELECTRIC (Ref # 21163) | 21163-3709 | 1 |
| BOLT,6X25 (Ref # 92002) | 92002-3714 | 2 |
| BOLT,6X12 (Ref # 92002A) | 92002-3763 | 1 |
| NUT,6MM (Ref # 92015) | 92015-3710 | 1 |
| WASHER,9.1X18X0.8 (Ref # 92022) | 92022-1132 | 1 |
| WASHER,6MM (Ref # 92022A) | 92022-3711 | 1 |
| WASHER,6MM (Ref # 92022B) | 92022-3713 | 1 |
| WASHER,12X24X1.0 (Ref # 92022C) | 92022-3731 | 1 |
| RING-O (Ref # 92055) | 92055-1276 | 1 |
| RING-O,4.5X2.0 (Ref # 92055A) | 92055-1370 | 1 |
| RING-O,STARTER MOTOR (Ref # 92055B) | 92055-1381 | 2 |
| BOLT (Ref # 92150) | 92150-3772 | 2 |