

# 1977 KH400-A4

## PARTS DIAGRAM

### OWNER TOOLS

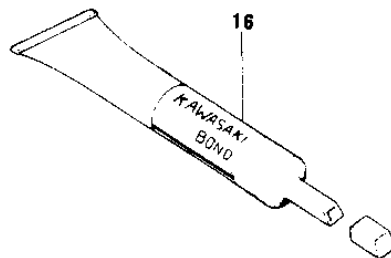
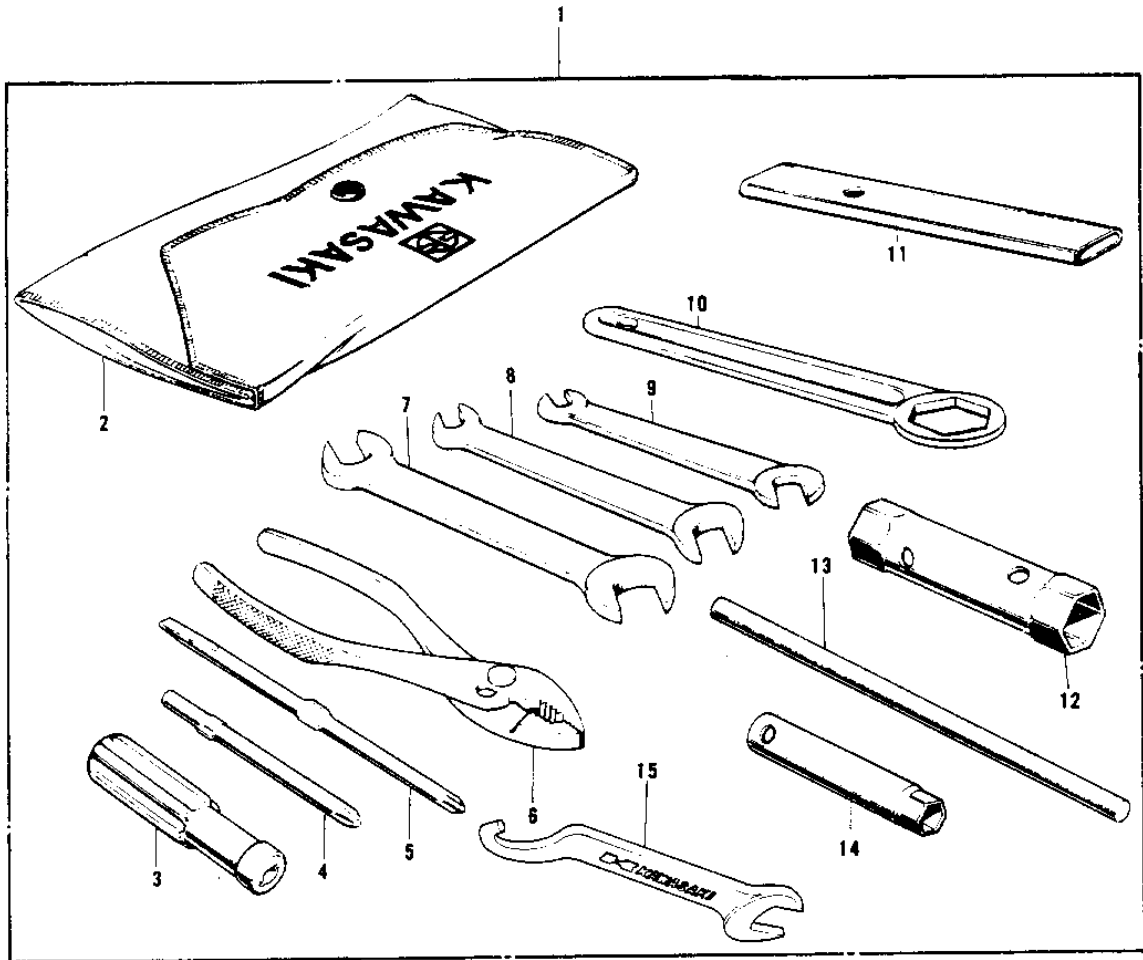

# 1977 KH400-A4

## PARTS LIST OWNER TOOLS

**ITEM NAME**

**PART NUMBER**

**QUANTITY**

---