

1966 Samurai

PARTS DIAGRAM

MUFFLER/SPARK ARRESTER A1SS-B, A7SS-B

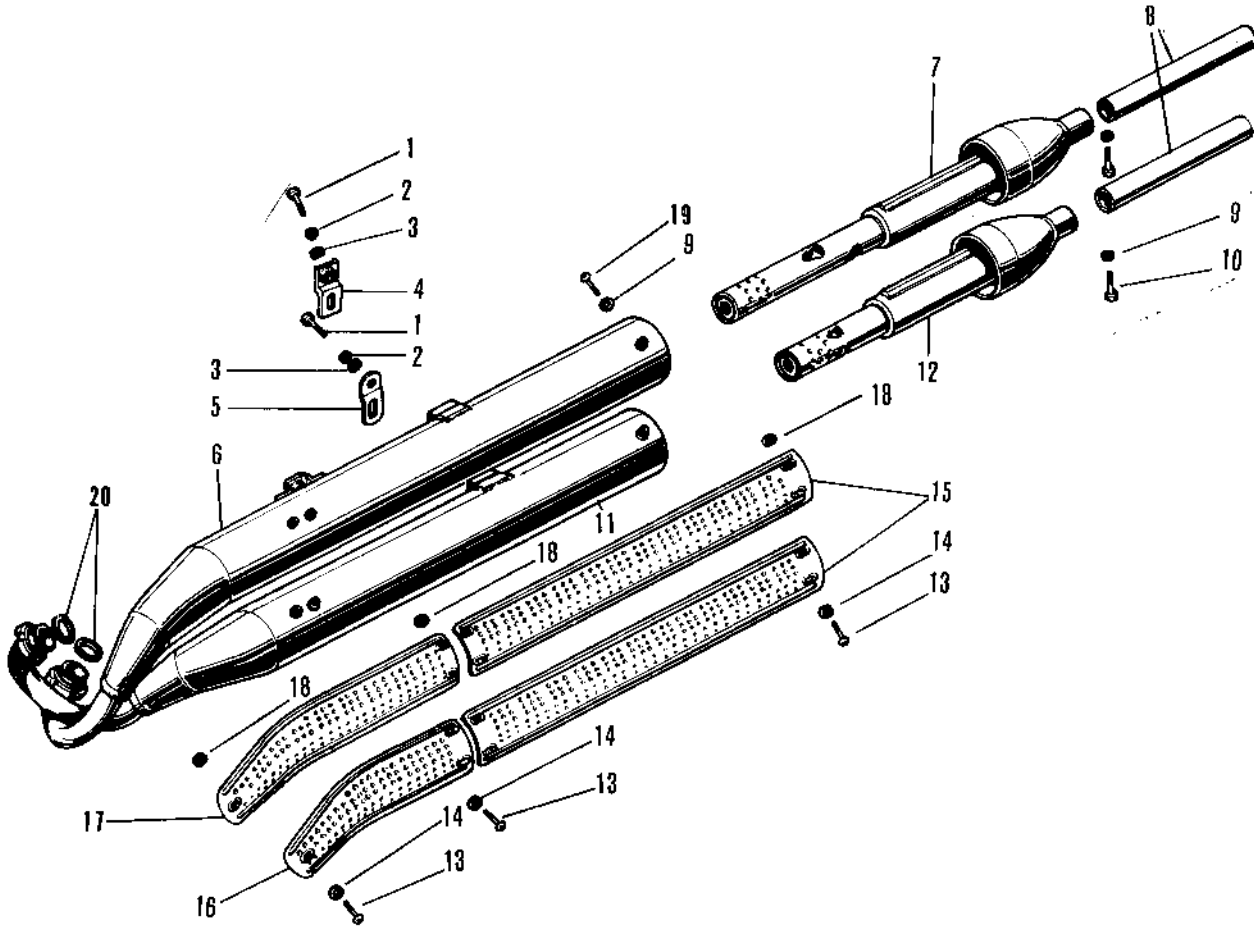

1966 Samurai

PARTS LIST

MUFFLER/SPARK ARRESTER A1SS-B, A7SS-B

ITEM NAME

PART NUMBER

QUANTITY
