

# 1982 KLT200

## PARTS DIAGRAM

### CRANKCASE ('81-'82 KLT200-A1/A2/A3)

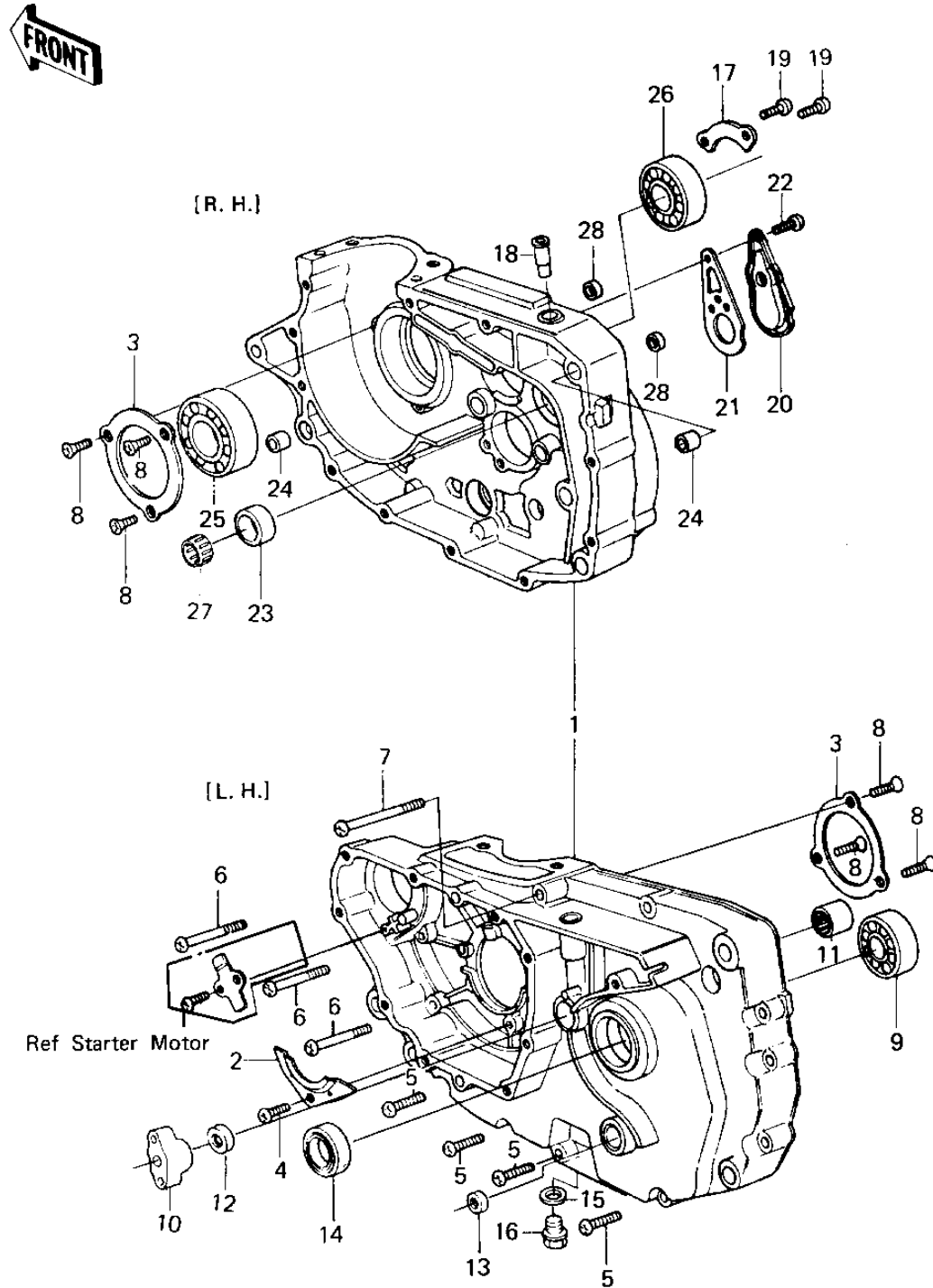

# 1982 KLT200

## PARTS LIST

CRANKCASE ('81-'82 KLT200-A1/A2/A3)

**ITEM NAME**

**PART NUMBER**

**QUANTITY**

---