

1990 X2

PARTS DIAGRAM

Starter Motor

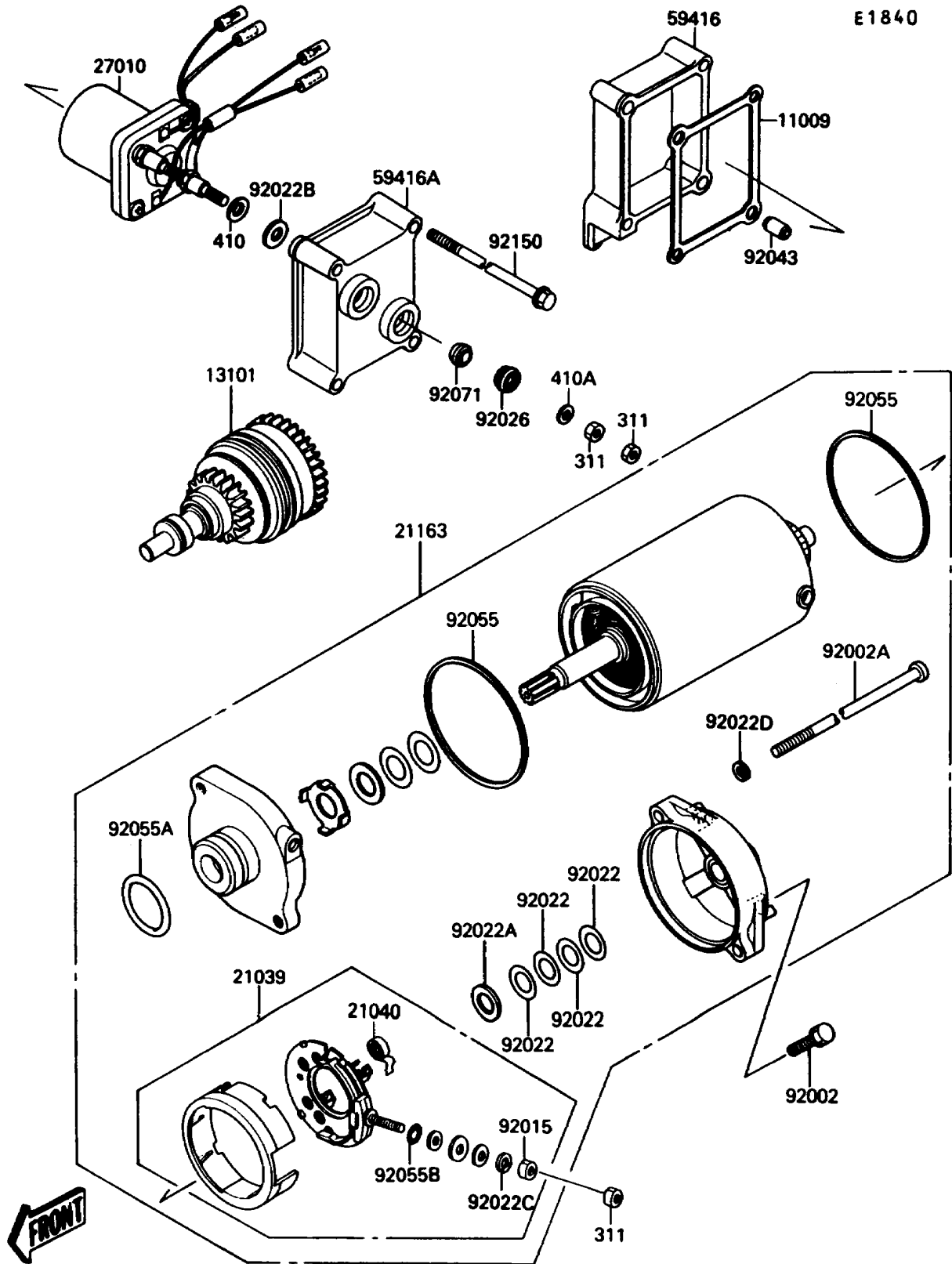

1990 X2

PARTS LIST

Starter Motor

ITEM NAME

PART NUMBER

QUANTITY
