

# 1995 Ninja<sup>®</sup> 500

## PARTS DIAGRAM

### Breather Cover/Oil Pan

E 1432

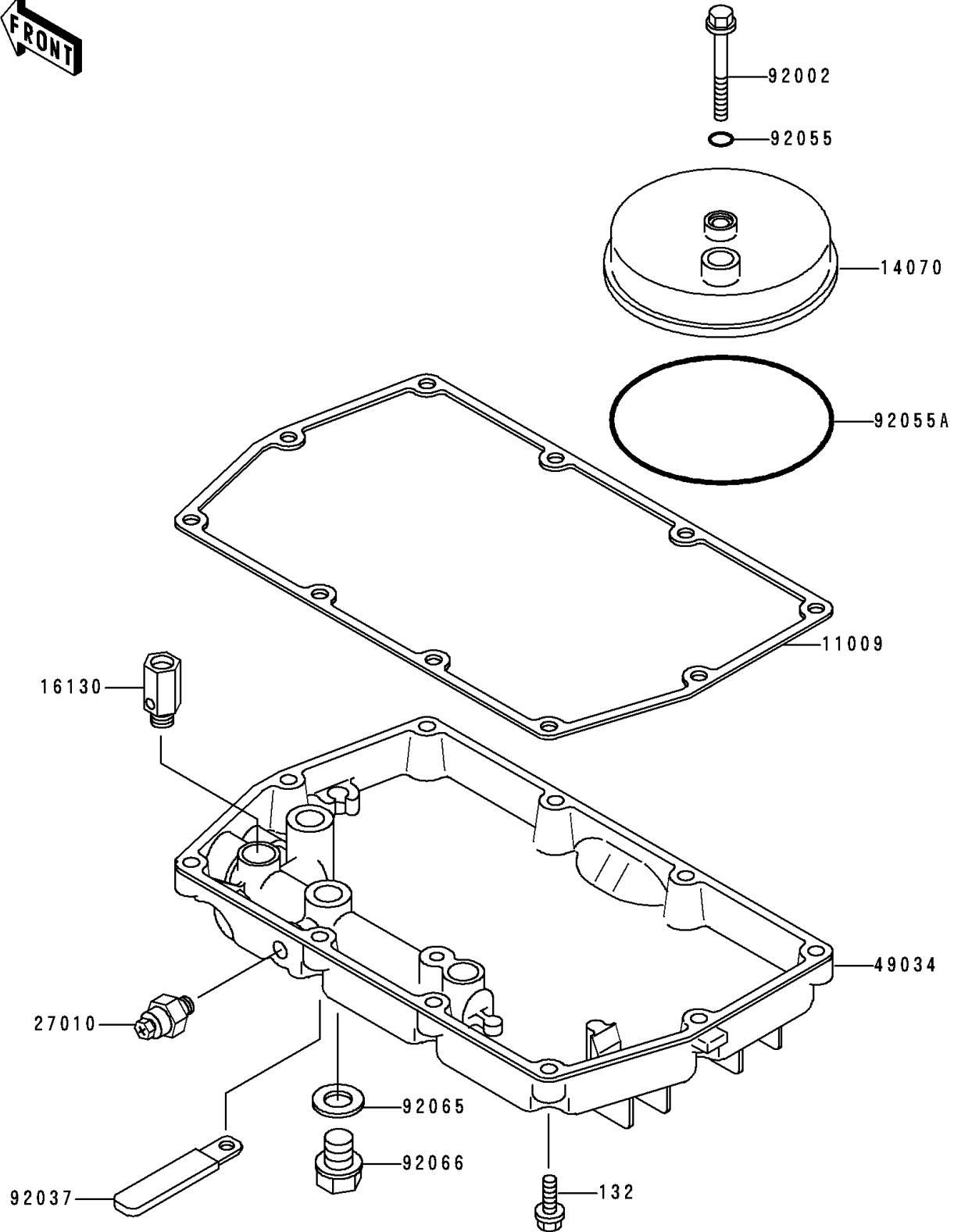

# 1995 Ninja<sup>®</sup> 500

## PARTS LIST

### Breather Cover/Oil Pan

ITEM NAME	PART NUMBER	QUANTITY
-----------	-------------	----------

---