

# 1993 Ninja<sup>®</sup> 250R

## PARTS DIAGRAM

### Cables

F2540

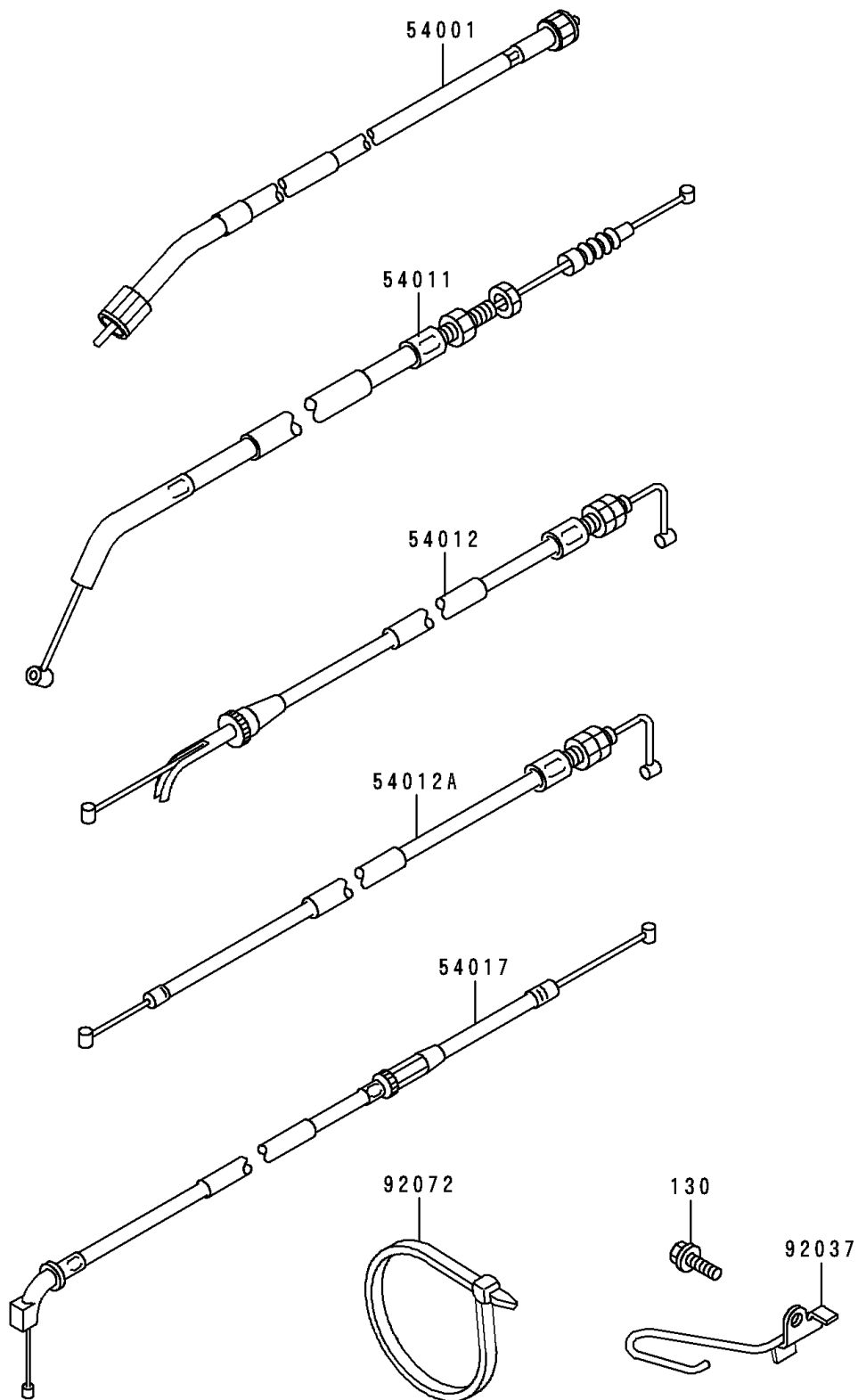

# 1993 Ninja<sup>®</sup> 250R

## PARTS LIST

### Cables

**ITEM NAME**

**PART NUMBER**

**QUANTITY**

---