

# 2001 Ninja<sup>®</sup> 250R

## PARTS DIAGRAM

### Rear Brake(F15-F17)

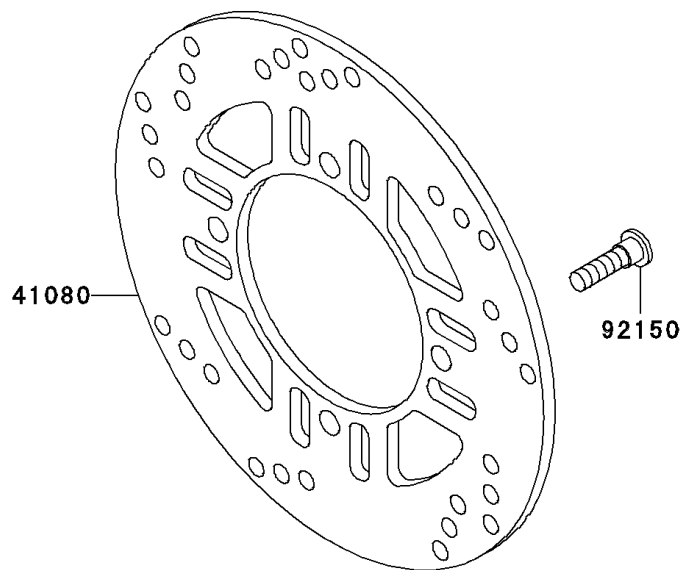
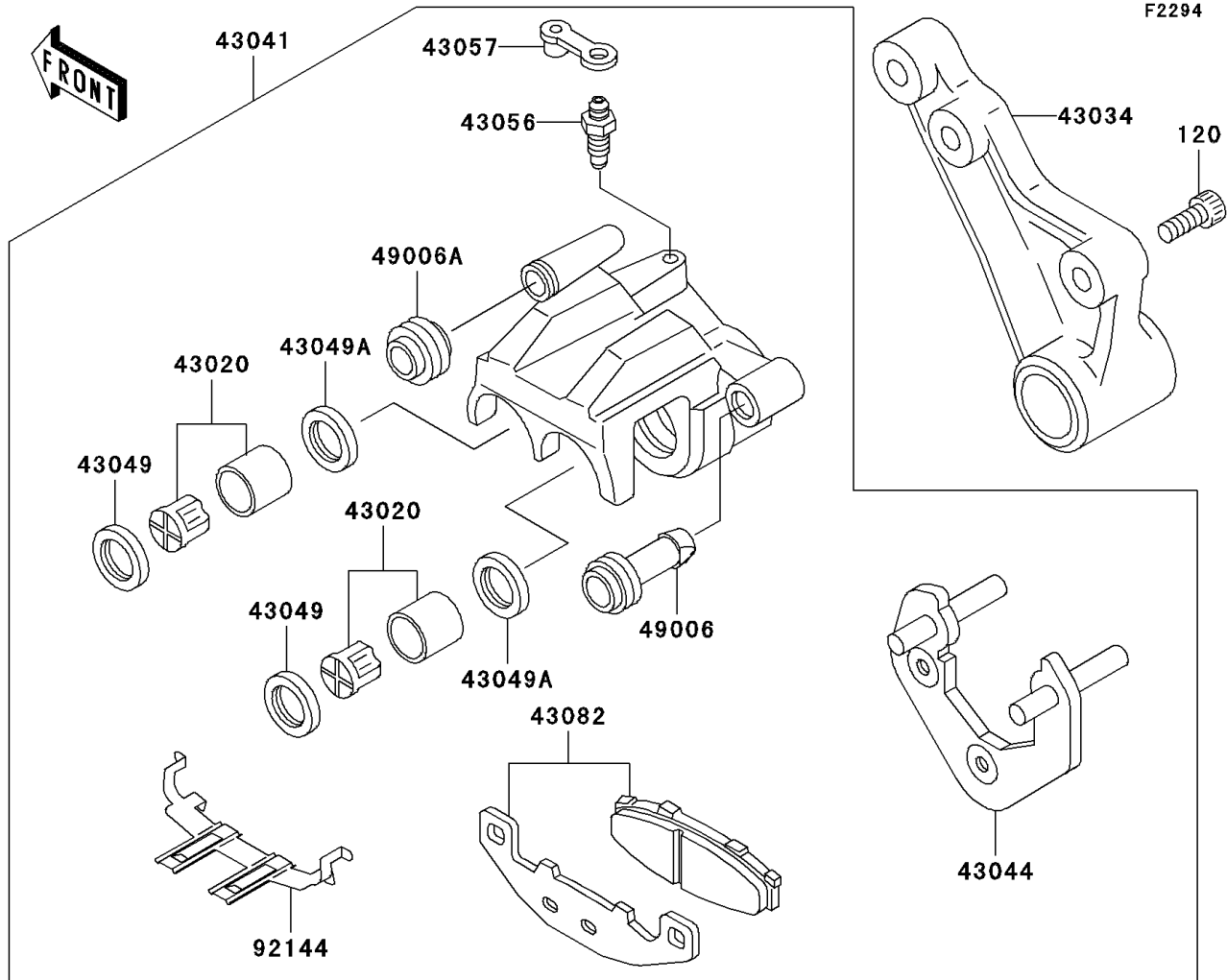

# 2001 Ninja<sup>®</sup> 250R

## PARTS LIST

Rear Brake(F15-F17)

**ITEM NAME**

**PART NUMBER**

**QUANTITY**

---