

2000 Vulcan 500 LTD

PARTS DIAGRAM

Crankcase Bolt Pattern

E1412

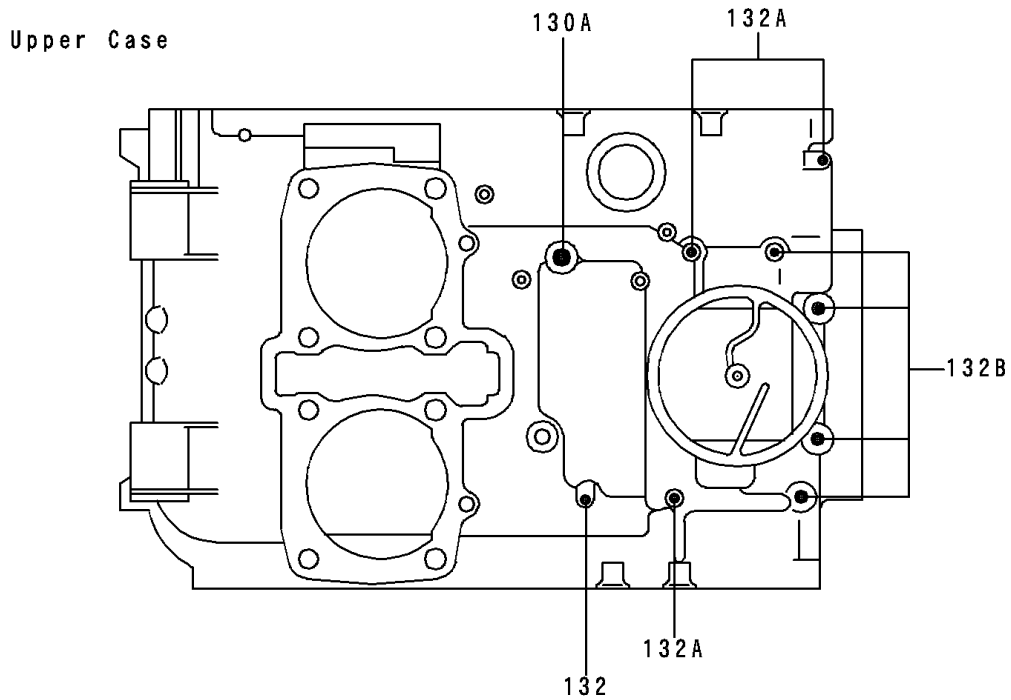

Lower Case

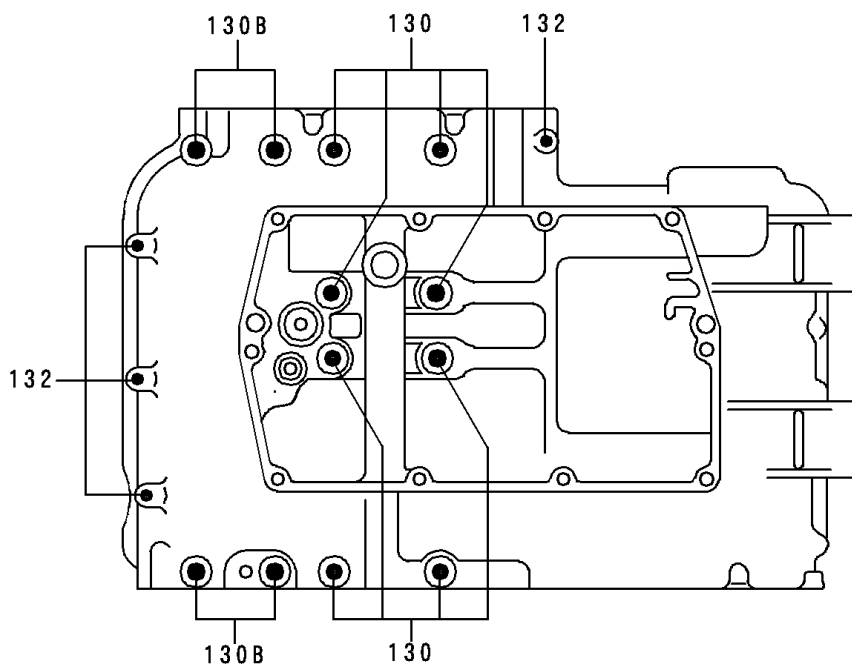

2000 Vulcan 500 LTD

PARTS LIST

Crankcase Bolt Pattern

ITEM NAME

PART NUMBER

QUANTITY
