

1990 Vulcan 500

PARTS DIAGRAM

Chassis Electrical Equipment

F2760

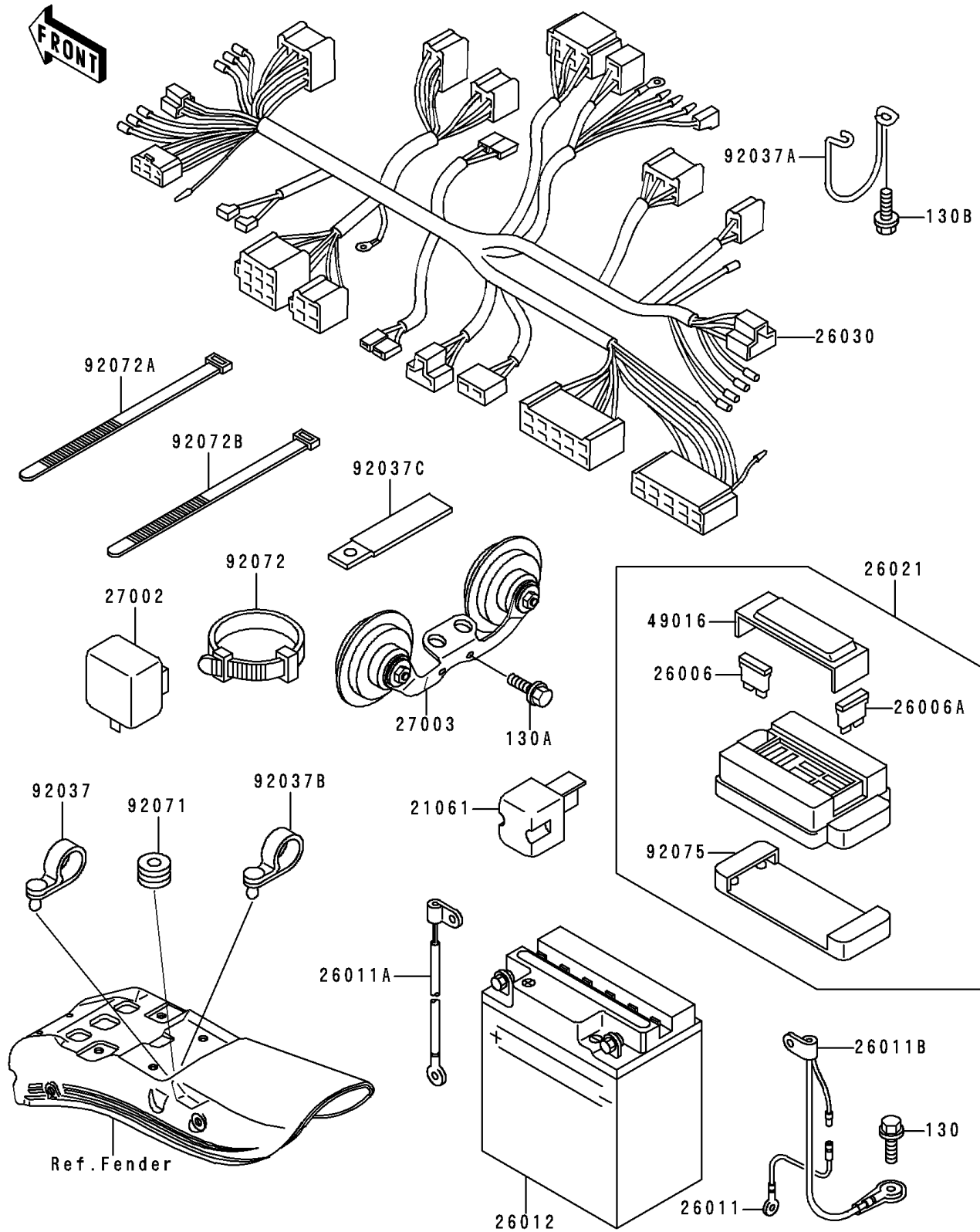

1990 Vulcan 500

PARTS LIST

Chassis Electrical Equipment

ITEM NAME

PART NUMBER

QUANTITY
