

2013 NINJA® ZX™-14R PARTS DIAGRAM

Valve(s)

E1210

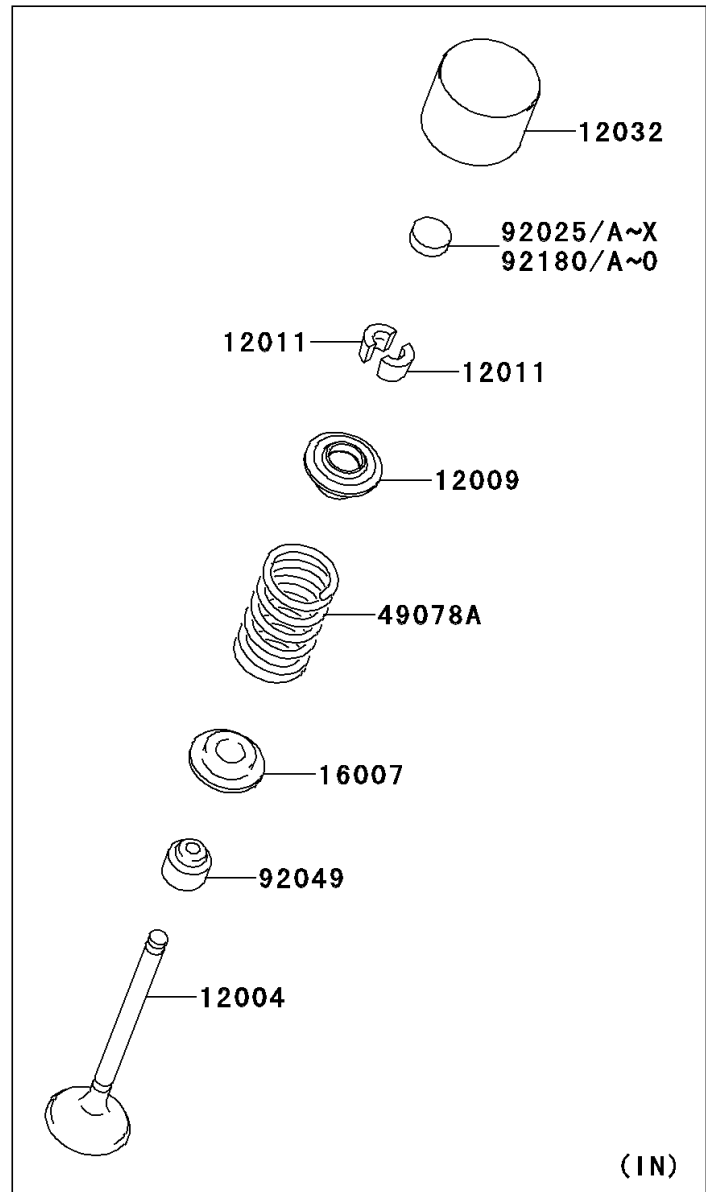
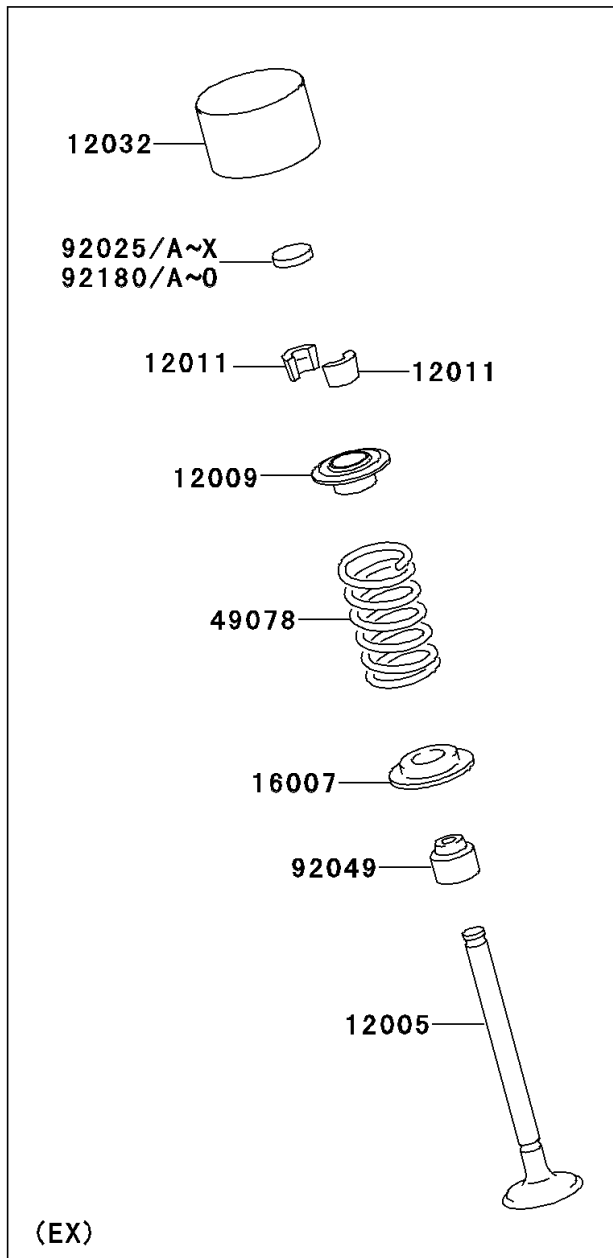

2013 NINJA® ZX™-14R PARTS LIST

Valve(s)

ITEM NAME	PART NUMBER	QUANTITY
VALVE-INTAKE (Ref # 12004)	12004-0715	1
VALVE-EXHAUST (Ref # 12005)	12005-0037	1
RETAINER-VALVE SPRING (Ref # 12009)	12009-0009	1
COLLET (Ref # 12011)	12011-1051	1
TAPPET,D26.5 (Ref # 12032)	12032-0013	1
SEAT-SPRING (Ref # 16007)	16007-0023	1
SPRING-ENGINE VALVE,EXHAUST (Ref # 49078)	49078-0712	1
SPRING-ENGINE VALVE,INTAKE (Ref # 49078A)	49078-0713	1
SHIM,T=2.00 (Ref # 92025)	92025-1870	1
SHIM,T=2.05 (Ref # 92025A)	92025-1871	1
SHIM,T=2.10 (Ref # 92025B)	92025-1872	1
SHIM,T=2.15 (Ref # 92025C)	92025-1873	1
SHIM,T=2.20 (Ref # 92025D)	92025-1874	1
SHIM,T=2.25 (Ref # 92025E)	92025-1875	1
SHIM,T=2.30 (Ref # 92025F)	92025-1876	1
SHIM,T=2.35 (Ref # 92025G)	92025-1877	1
SHIM,T=2.40 (Ref # 92025H)	92025-1878	1
SHIM,T=2.45 (Ref # 92025I)	92025-1879	1
SHIM,T=2.50 (Ref # 92025J)	92025-1880	1
SHIM,T=2.55 (Ref # 92025K)	92025-1881	1
SHIM,T=2.60 (Ref # 92025L)	92025-1882	1
SHIM,T=2.65 (Ref # 92025M)	92025-1883	1
SHIM,T=2.70 (Ref # 92025N)	92025-1884	1
SHIM,T=2.75 (Ref # 92025O)	92025-1885	1
SHIM,T=2.80 (Ref # 92025P)	92025-1886	1
SHIM,T=2.85 (Ref # 92025Q)	92025-1887	1
SHIM,T=2.90 (Ref # 92025R)	92025-1888	1
SHIM,T=2.95 (Ref # 92025S)	92025-1889	1
SHIM,T=3.00 (Ref # 92025T)	92025-1890	1

2013 NINJA® ZX™-14R PARTS LIST

Valve(s)

ITEM NAME	PART NUMBER	QUANTITY
SHIM,T=2.425 (Ref # 92025U)	92025-1982	1
SHIM,T=2.475 (Ref # 92025V)	92025-1983	1
SHIM,T=2.525 (Ref # 92025W)	92025-1984	1
SHIM,T=2.575 (Ref # 92025X)	92025-1985	1
SEAL-OIL,RVCI 5X8.7X8 (Ref # 92049)	92049-1509	1
SHIM,T=2.025 (Ref # 92180)	92180-0209	1
SHIM,T=2.075 (Ref # 92180A)	92180-0210	1
SHIM,T=2.125 (Ref # 92180B)	92180-0211	1
SHIM,T=2.175 (Ref # 92180C)	92180-0212	1
SHIM,T=2.225 (Ref # 92180D)	92180-0213	1
SHIM,T=2.275 (Ref # 92180E)	92180-0214	1
SHIM,T=2.325 (Ref # 92180F)	92180-0215	1
SHIM,T=2.825 (Ref # 92180G)	92180-0216	1
SHIM,T=2.875 (Ref # 92180H)	92180-0217	1
SHIM,T=2.925 (Ref # 92180I)	92180-0218	1
SHIM,T=2.975 (Ref # 92180J)	92180-0219	1
SHIM,T=2.375 (Ref # 92180K)	92180-1058	1
SHIM,T=2.625 (Ref # 92180L)	92180-1059	1
SHIM,T=2.675 (Ref # 92180M)	92180-1194	1
SHIM,T=2.725 (Ref # 92180N)	92180-1195	1
SHIM,T=2.775 (Ref # 92180O)	92180-1196	1