

2012 KX™ 450F PARTS DIAGRAM

Muffler(s)

E1140

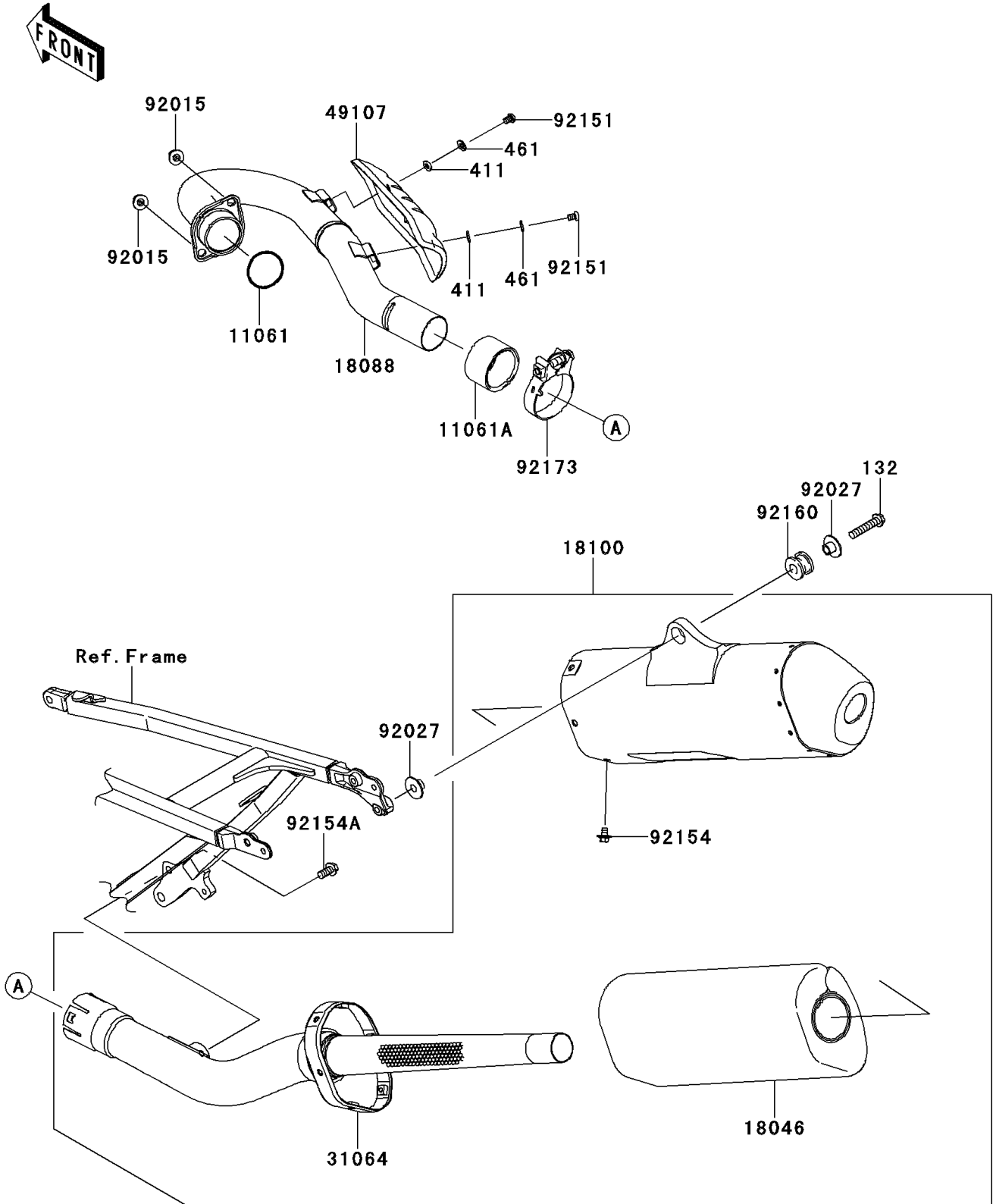

2012 KX™ 450F PARTS LIST

Muffler(s)

ITEM NAME	PART NUMBER	QUANTITY
BOLT-FLANGED-SMALL,8X40 (Ref # 132)	132BA0840	1
WASHER-PLAIN,6MM (Ref # 411)	411S0600	2
WASHER-SPRING,6MM (Ref # 461)	461S0600	2
GASKET,38.9X46.4X3.0 (Ref # 11061)	11061-0082	1
GASKET,CONNECTING (Ref # 11061A)	11061-0434	1
WOOL (Ref # 18046)	18046-0234	1
PIPE-EXHAUST (Ref # 18088)	18088-0609	1
BODY-ASSY-MUFFLER (Ref # 18100)	18100-0115	1
PIPE-COMP (Ref # 31064)	31064-0212	1
COVER-EXHAUST PIPE (Ref # 49107)	49107-0159	1
NUT,8MM (Ref # 92015)	92015-1402	2
COLLAR,FLANGED,8.8X10.6 (Ref # 92027)	92027-1653	2
BOLT,SOCKET,6X10 (Ref # 92151)	92151-1449	2
BOLT,FLANGED,6X10 (Ref # 92154)	92154-0396	6
BOLT,FLANGED,8X18 (Ref # 92154A)	92154-0519	1
DAMPER,MUFFLER MOUNT (Ref # 92160)	92160-1116	1
CLAMP,57MM (Ref # 92173)	92173-0885	1