

2013 KX™65 PARTS DIAGRAM

Swingarm

F2141

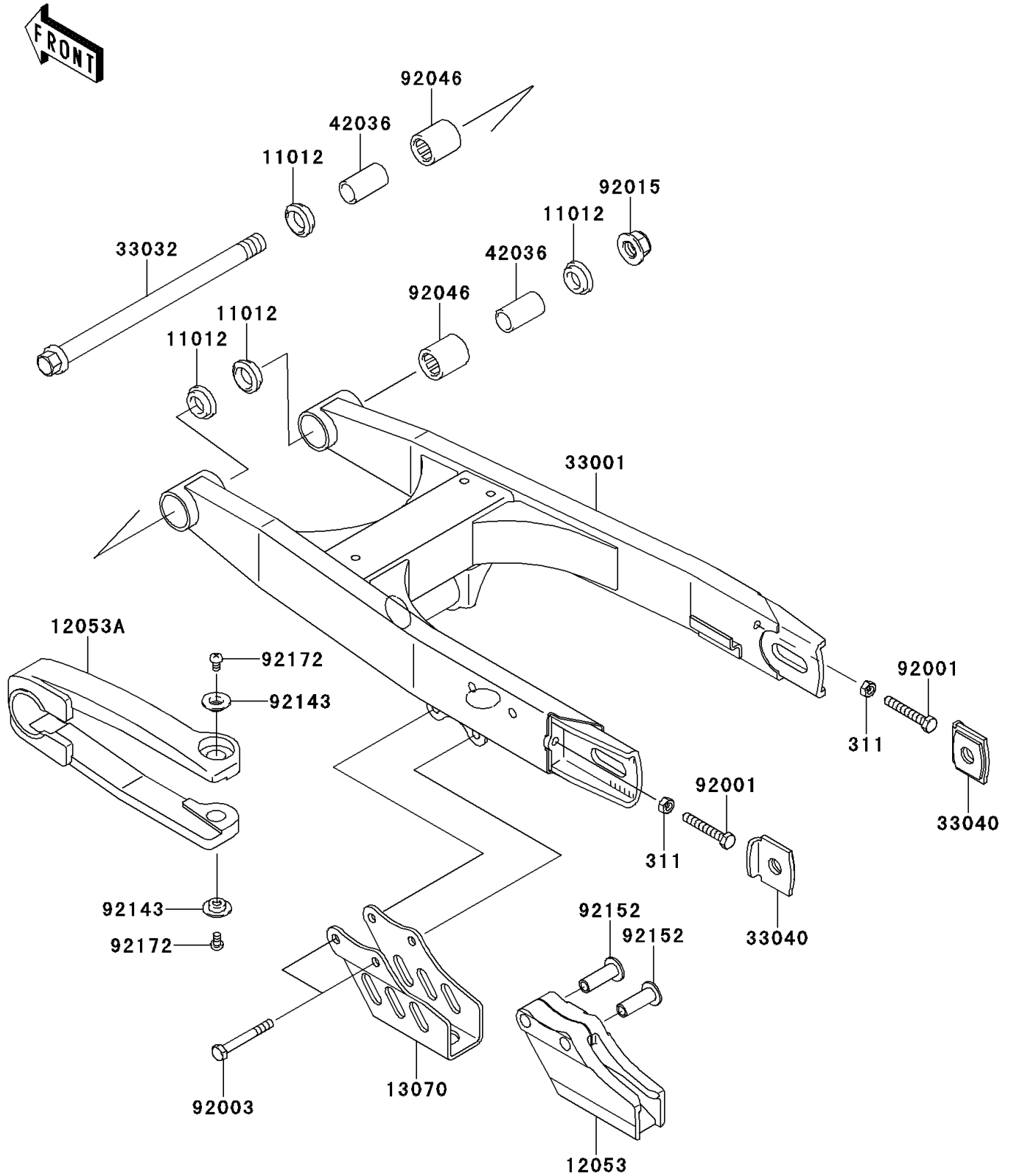

2013 KX™65 PARTS LIST

Swingarm

ITEM NAME	PART NUMBER	QUANTITY
NUT-HEX,6MM (Ref # 311)	311AA0600	1
CAP (Ref # 11012)	11012-1263	1
GUIDE-CHAIN,RR (Ref # 12053)	12053-1436	1
GUIDE-CHAIN,FR (Ref # 12053A)	12053-1456	1
GUIDE,CHAIN (Ref # 13070)	13070-1347	1
ARM-COMP-SWING,P.SILVER (Ref # 33001)	33001-1634-458	1
SHAFT-SWING ARM (Ref # 33032)	33032-1194	1
ADJUSTER-CHAIN (Ref # 33040)	33040-1188	1
SLEEVE,SWING ARM,L=34 (Ref # 42036)	42036-1067	1
BOLT,6X39 (Ref # 92001)	92001-1463	1
BOLT,FLANGED,6X48 (Ref # 92003)	92003-179	1
NUT,LOCK,FLANGED,12MM (Ref # 92015)	92015-1433	1
BEARING-NEEDLE (Ref # 92046)	92046-1046	1
COLLAR (Ref # 92143)	92143-1676	1
COLLAR (Ref # 92152)	92152-1215	1
SCREW,5X8 (Ref # 92172)	92172-0119	1