

2010 KLX®110L PARTS DIAGRAM

Guard(s)

F2680

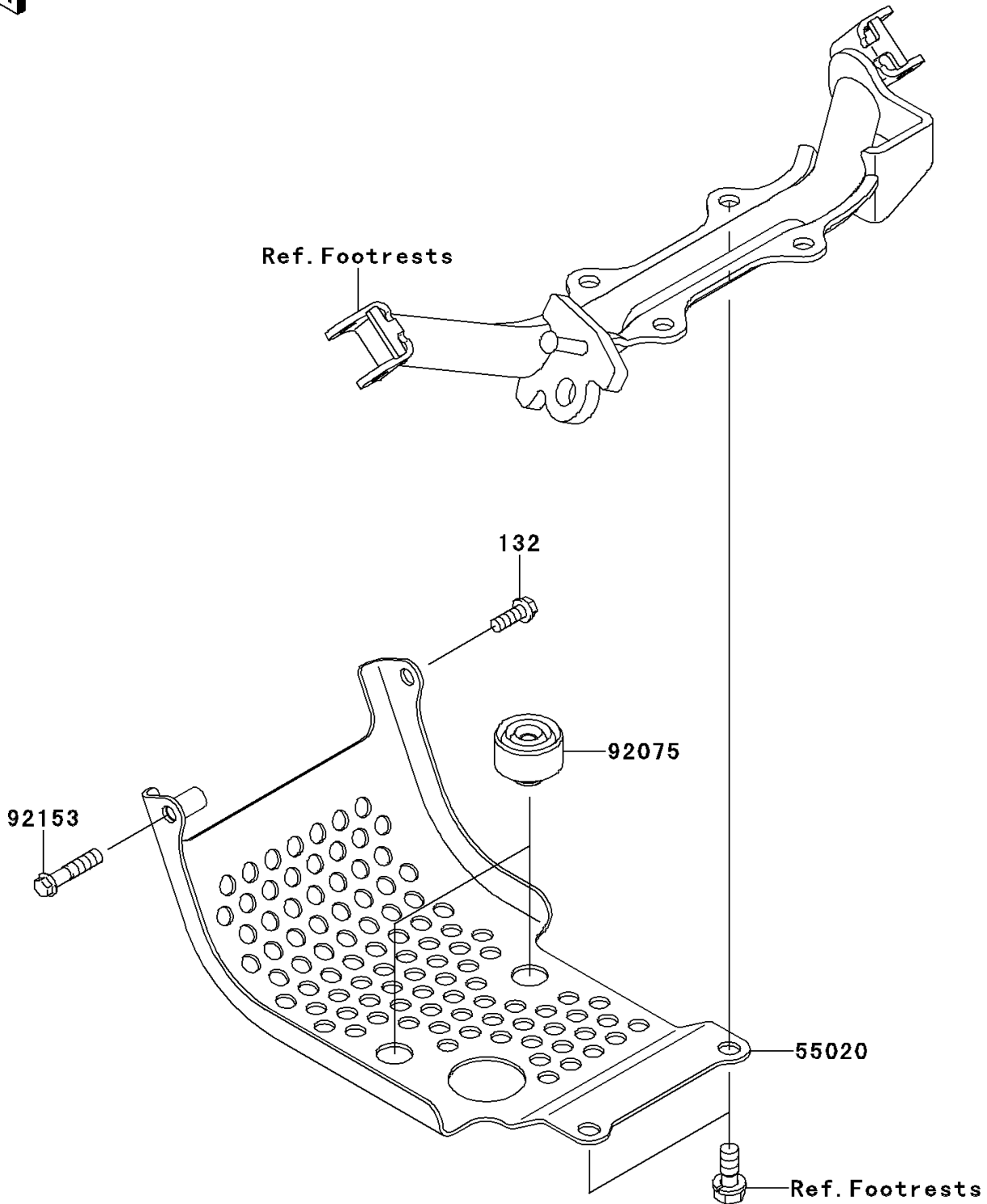

2010 KLX®110L PARTS LIST

Guard(s)

ITEM NAME	PART NUMBER	QUANTITY
BOLT-FLANGED-SMALL,6X16 (Ref # 132)	132BD0616	1
GUARD,ENGINE (Ref # 55020)	55020-1784	1
DAMPER (Ref # 92075)	92075-015	1
BOLT,FLANGED,6X30 (Ref # 92153)	92153-1187	1