

2006 Ninja® 650R PARTS DIAGRAM

Handlebar

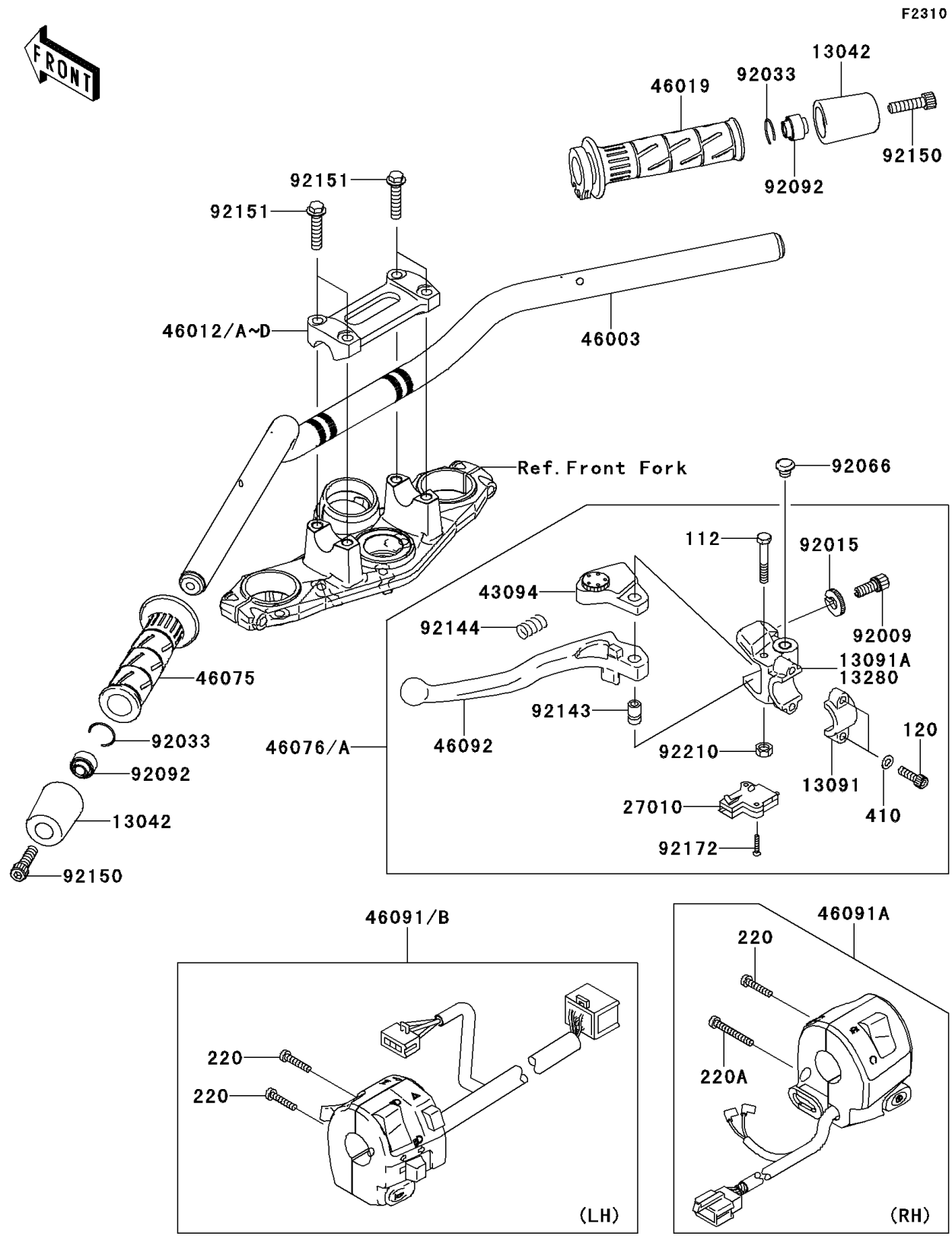

2006 Ninja® 650R PARTS LIST

Handlebar

ITEM NAME	PART NUMBER	QUANTITY
BOLT-UPSET,6X40 (Ref # 112)	112C0640	1
BOLT-SOCKET,6X20 (Ref # 120)	120S0620	2
SCREW-PAN-CROS,5X25 (Ref # 220)	220C0525	3
SCREW-PAN-CROS,5X40 (Ref # 220A)	220C0540	1
WASHER-PLAIN-SMALL,6MM,BLACK (Ref # 410)	410F0600	2
WEIGHT,HANDLE (Ref # 13042)	13042-1006	2
HOLDER,CLUTCH LEVER (Ref # 13091)	13091-1624	1
HOLDER,CLUTCH LEVER (Ref # 13091A)	13091-1652	1
SWITCH,CLUTCH,BLACK (Ref # 27010)	27010-1094	1
ADJUSTER,CLUTCH LEVER (Ref # 43094)	43094-1053	1
HANDLE,P.SILVER (Ref # 46003)	46003-0093-458	1
HOLDER-HANDLE,UPP,P.RED (Ref # 46012B)	46012-0010-796	1
GRIP-ASSY,THROTTLE (Ref # 46019)	46019-0001	1
GRIP,LH (Ref # 46075)	46075-1144	1
LEVER-ASSY-GRIP,CLUTCH (Ref # 46076A)	46076-1180	1
HOUSING-ASSY-CONTROL,LH (Ref # 46091)	46091-0087	1
HOUSING-ASSY-CONTROL,RH (Ref # 46091A)	46091-0092	1
LEVER-GRIP,CLUTCH (Ref # 46092)	46092-1162	1
SCREW,CABLE ADJUST,8MM,BLACK (Ref # 92009)	92009-1134	1
NUT,CABLE ADJUST LOCK,8MM,BLK (Ref # 92015)	92015-1197	1
RING-SNAP,OD=22.2 (Ref # 92033)	92033-1102	2
PLUG,9.5X8,POLYETHYLENE (Ref # 92066)	92066-1077	1
BUSHING-RUBBER,HANDLE (Ref # 92092)	92092-1018	2
COLLAR (Ref # 92143)	92143-1379	1
SPRING (Ref # 92144)	92144-1467	1
BOLT,SOCKET,8X30 (Ref # 92150)	92150-1604	2
BOLT,FLANGED,8X35 (Ref # 92151)	92151-1537	4
SCREW,3X16 (Ref # 92172)	92172-0183	2
NUT,LOCK,6MM (Ref # 92210)	92210-0006	1

2006 Ninja® 650R PARTS LIST

Handlebar

ITEM NAME	PART NUMBER	QUANTITY
HOLDER-HANDLE,UPP,M.BRONZE (Ref # 46012A)	46012-0010-793	1