

Mule 500 PARTS DIAGRAM

Carrier(s)

F2520

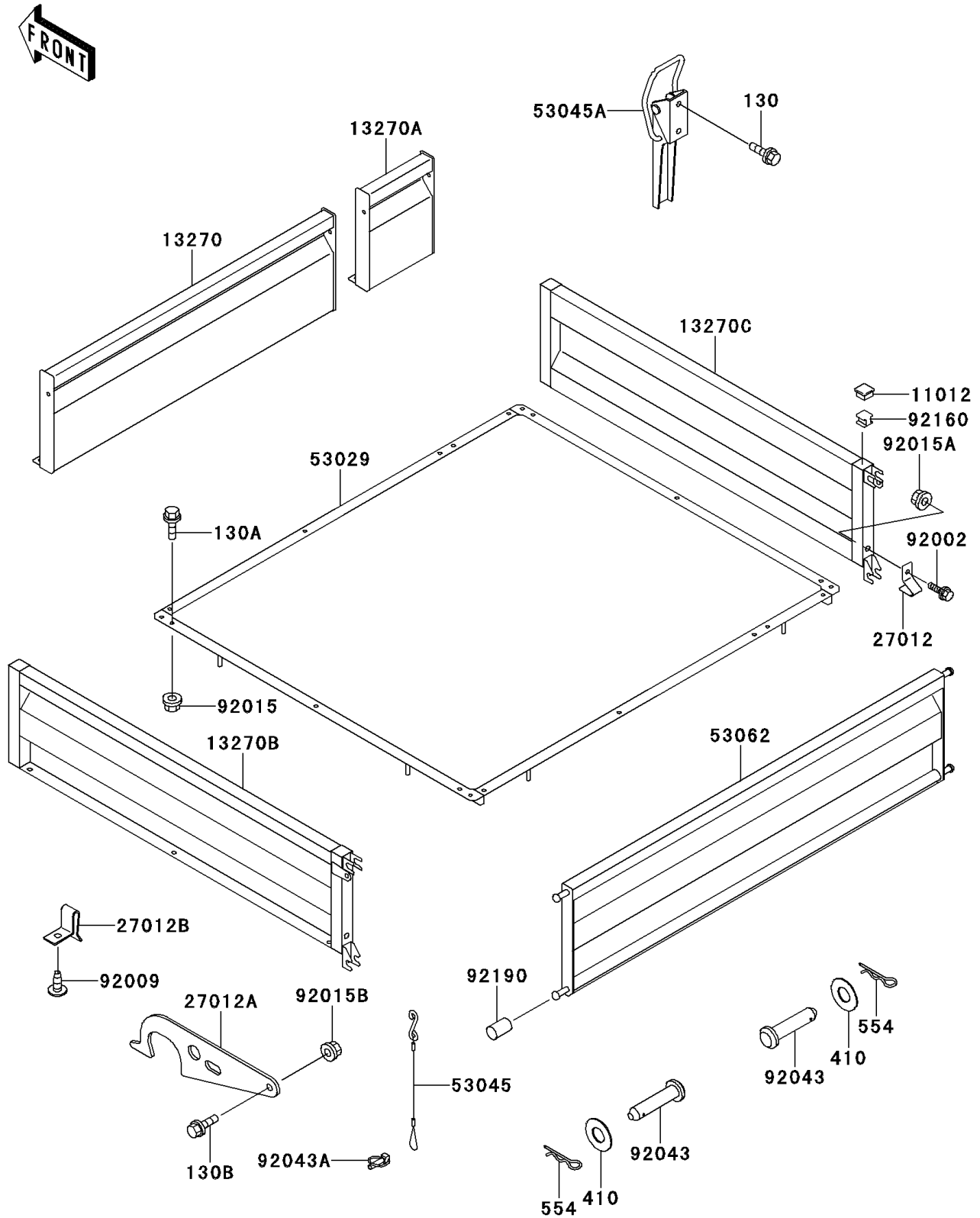

Mule 500 PARTS LIST

Carrier(s)

ITEM NAME	PART NUMBER	QUANTITY
BOLT-FLANGED (Ref # 130)	130J0612	1
BOLT-FLANGED,6X16,BLACK (Ref # 130A)	130J0616	1
BOLT-FLANGED,6X40,BLACK (Ref # 130B)	130J0640	1
WASHER-PLAIN-SMALL,12MM (Ref # 410)	410B1200	1
PIN-SNAP,12MM (Ref # 554)	554A1200	1
CAP (Ref # 11012)	11012-1784	1
PLATE,CARRIER,FR,LH,F.RED (Ref # 13270)	13270-1084-B1	1
PLATE,CARRIER,FR,RH,F.RED (Ref # 13270A)	13270-1087-B1	1
PLATE,CARRIER,SIDE,LH,F.RED (Ref # 13270B)	13270-1090-B1	1
PLATE,CARRIER,SIDE,RH,F.RED (Ref # 13270C)	13270-1092-B1	1
HOOK,TAIL GATE (Ref # 27012)	27012-1406	1
HOOK,CARRIER (Ref # 27012A)	27012-1444	1
HOOK,CARRIER (Ref # 27012B)	27012-1445	1
CARRIER,F.RED (Ref # 53029)	53029-1145-B1	1
HOOK-ASSY,TALE GATE (Ref # 53045)	53045-1060	1
HOOK-ASSY (Ref # 53045A)	53045-1063	1
GATE-TAIL,F.RED (Ref # 53062)	53062-1005-B1	1
BOLT,8X50 (Ref # 92002)	92002-1182	1
SCREW (Ref # 92009)	92009-1166	1
NUT,FLANGED,6MM (Ref # 92015)	92015-1386	1
NUT,FLANGED,8MM (Ref # 92015A)	92015-1408	1
NUT,LOCK,FLANGED,6MM (Ref # 92015B)	92015-1675	1
PIN,12X54 (Ref # 92043)	92043-1451	1
PIN (Ref # 92043A)	92043-1490	1
DAMPER (Ref # 92160)	92160-1191	1
TUBE,8X10X15 (Ref # 92190)	92190-1467	1