

Mule 500 PARTS DIAGRAM

Swingarm

F2141

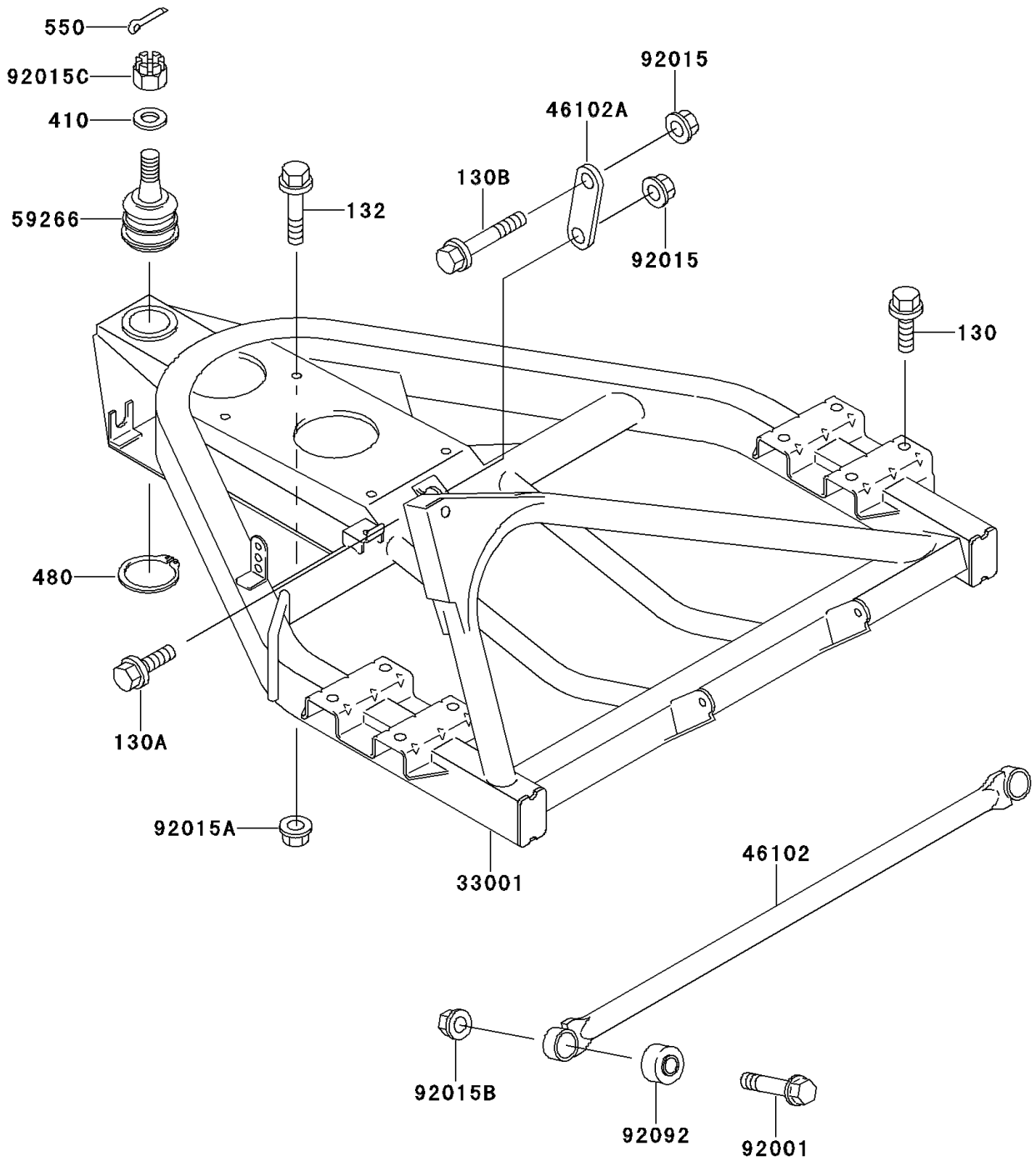

Mule 500 PARTS LIST

Swingarm

ITEM NAME	PART NUMBER	QUANTITY
BOLT-FLANGED,10X16 (Ref # 130)	130J1016	1
BOLT-FLANGED,10X20 (Ref # 130A)	130J1020	1
BOLT-FLANGED,10X55 (Ref # 130B)	130J1055	1
BOLT-FLANGED-SMALL (Ref # 132)	132G0835	1
WASHER-PLAIN-SMALL,14MM (Ref # 410)	410B1400	1
CIRCLIP-TYPE-C,38MM (Ref # 480)	480J3800	1
PIN-COTTER,3.2X30 (Ref # 550)	550D3230	1
ARM-COMP-SWING (Ref # 33001)	33001-1373	1
ROD (Ref # 46102)	46102-1297	1
ROD (Ref # 46102A)	46102-1298	1
JOINT-BALL (Ref # 59266)	59266-1087	1
BOLT,FLANGED,10X44 (Ref # 92001)	92001-1702	1
NUT,FLANGED,10MM (Ref # 92015)	92015-1335	1
NUT,8MM (Ref # 92015A)	92015-1432	1
NUT,FLANGED,10MM (Ref # 92015B)	92015-1502	1
NUT,CASTLE,14MM (Ref # 92015C)	92015-1841	1
BUSHING-RUBBER (Ref # 92092)	92092-1072	1