

Mule 500 PARTS DIAGRAM

Carburetor

E1611

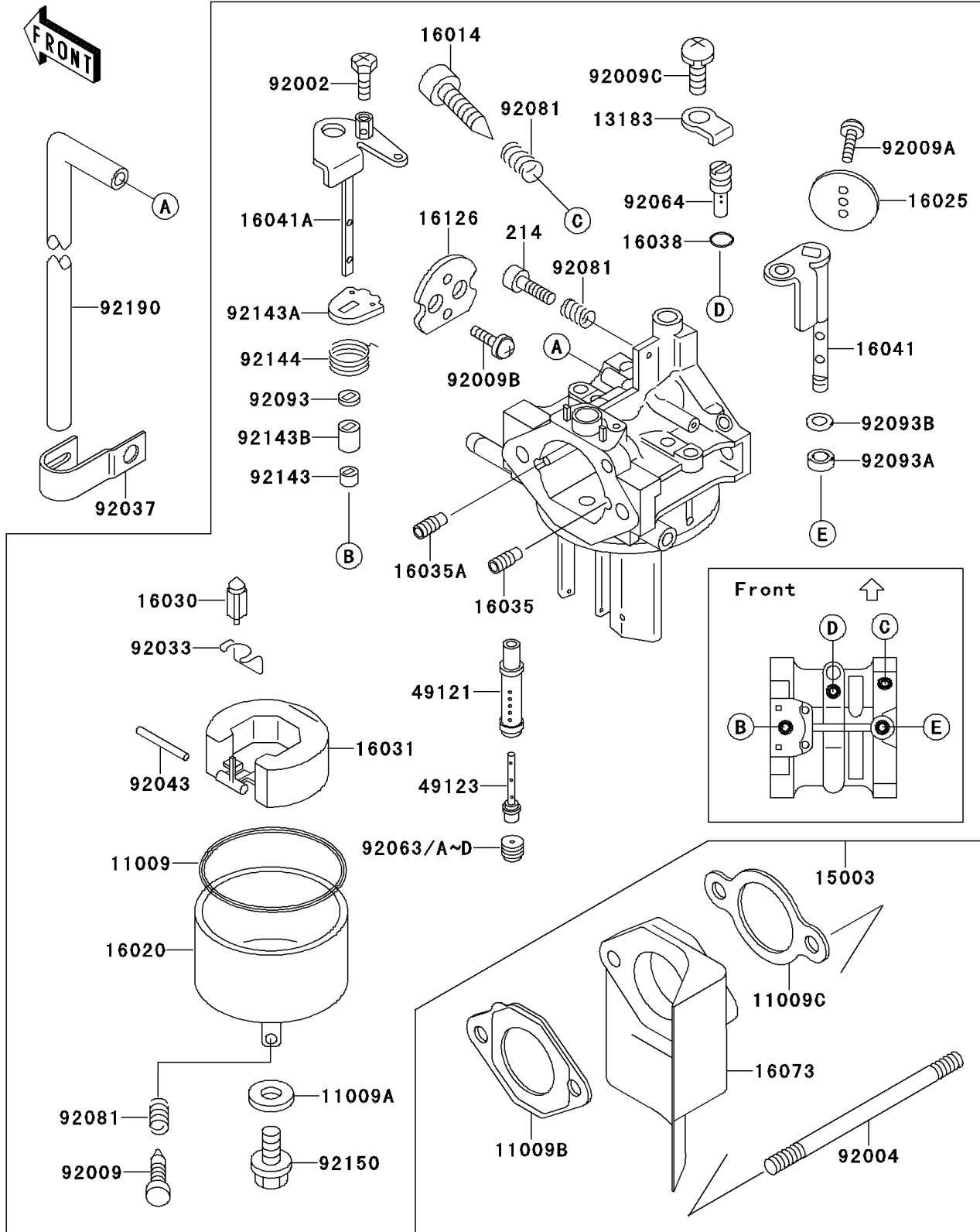

Mule 500 PARTS LIST

Carburetor

ITEM NAME	PART NUMBER	QUANTITY
GASKET,FLOAT CHAMBER (Ref # 11009)	11009-2024	1
GASKET (Ref # 11009A)	11009-2025	1
GASKET,CARBURETOR (Ref # 11009B)	11009-2827	1
GASKET,INSULATOR (Ref # 11009C)	11009-2939	1
PLATE (Ref # 13183)	13183-2252	1
CARBURETOR-ASSY. (Ref # 15003)	15003-2104	1
SCREW-PILOT AIR (Ref # 16014)	16014-2004	1
CHAMBER-FLOAT (Ref # 16020)	16020-2051	1
VALVE-THROTTLE,#160 (Ref # 16025)	16025-2161	1
VALVE-FLOAT (Ref # 16030)	16030-2073	1
FLOAT (Ref # 16031)	16031-2066	1
JET-AIR,#1.8 (Ref # 16035)	16035-2056	1
JET-AIR,#1.2 (Ref # 16035A)	16035-2061	1
GASKET,PILOT JET (Ref # 16038)	16038-024	1
SHAFT-CARBURETOR,THROTTLE (Ref # 16041)	16041-2203	1
SHAFT-CARBURETOR,CHOKE (Ref # 16041A)	16041-2209	1
INSULATOR (Ref # 16073)	16073-2154	1
VALVE,CHOKE (Ref # 16126)	16126-2181	1
NOZZLE-MAIN,#32B (Ref # 49121)	49121-2164	1
HOLDER-MAIN JET (Ref # 49123)	49123-2060	1
BOLT (Ref # 92002)	92002-2008	1
STUD,6X80 (Ref # 92004)	92004-2125	1
SCREW,DRAIN (Ref # 92009)	92009-2015	1
SCREW,THROTTLE VALVE (Ref # 92009A)	92009-2080	1
SCREW,CHOKE VALVE (Ref # 92009B)	92009-2081	1
SCREW (Ref # 92009C)	92009-2244	1
RING-SNAP (Ref # 92033)	92033-2067	1
CLAMP (Ref # 92037)	92037-2081	1
PIN,FLOAT (Ref # 92043)	92043-2006	1

Mule 500 PARTS LIST

Carburetor

ITEM NAME	PART NUMBER	QUANTITY
JET-MAIN,#97.5 (Ref # 92063)	92063-2163	1
JET-MAIN,#95 (Ref # 92063A)	92063-2167	1
JET-MAIN,#100 (Ref # 92063B)	92063-2173	1
JET-MAIN,#105 (Ref # 92063C)	92063-2218	1
JET-MAIN,#102.5 (Ref # 92063D)	92063-2236	1
JET-PILOT,#45 (Ref # 92064)	92064-2063	1
SPRING (Ref # 92081)	92081-2009	1
SCREW-PAN+- (Ref # 214)	214B0414	1
SEAL (Ref # 92093)	92093-2081	1
SEAL (Ref # 92093A)	92093-2082	1
SEAL (Ref # 92093B)	92093-2083	1
COLLAR (Ref # 92143)	92143-2132	1
COLLAR (Ref # 92143A)	92143-2133	1
COLLAR (Ref # 92143B)	92143-2134	1
SPRING (Ref # 92144)	92144-2269	1
BOLT (Ref # 92150)	92150-2146	1
TUBE,6X10X175 (Ref # 92190)	92190-2051	1