

Mule 500 PARTS DIAGRAM

Crankcase

E1411

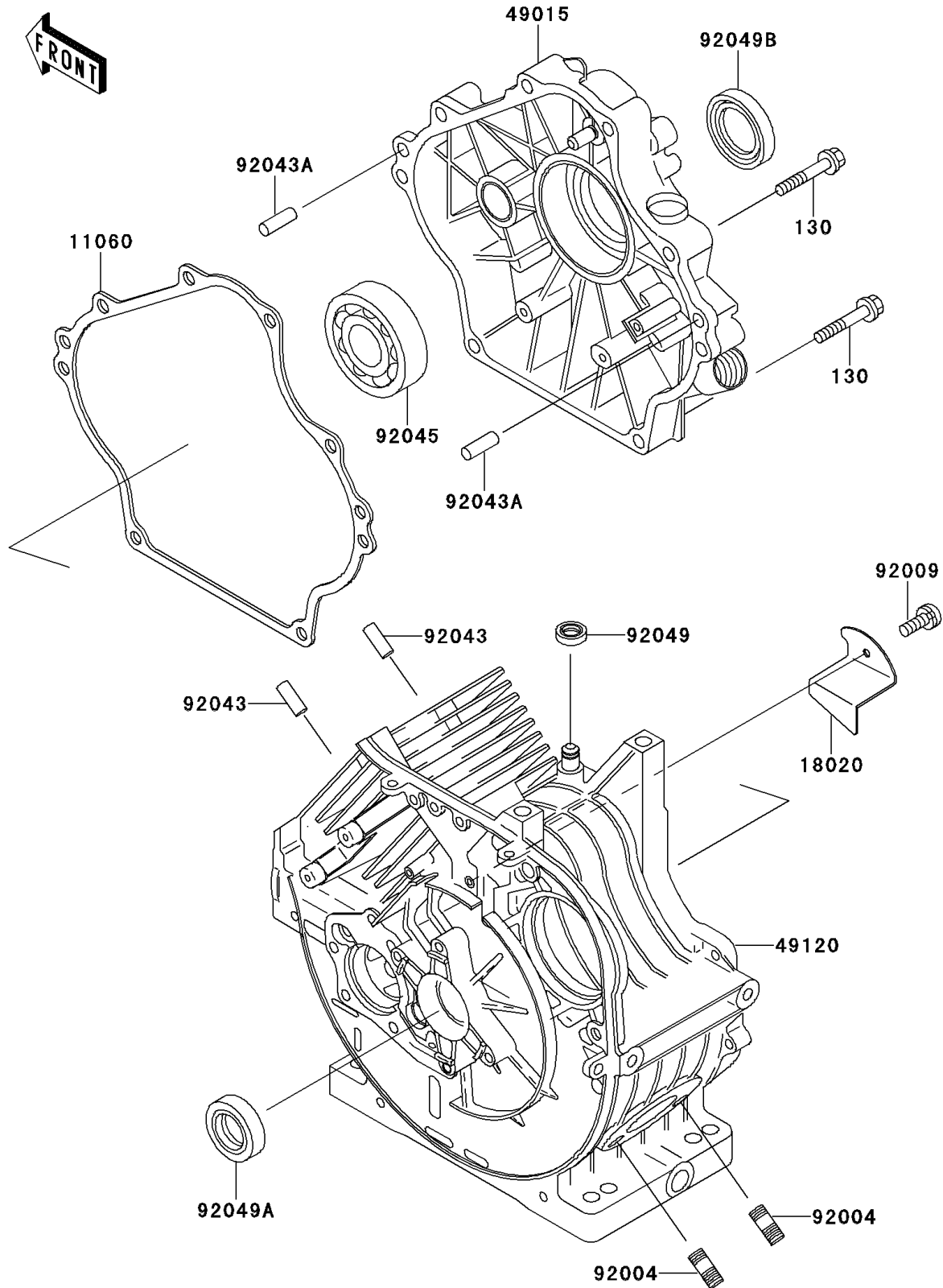

Mule 500 PARTS LIST

Crankcase

ITEM NAME	PART NUMBER	QUANTITY
BOLT-FLANGED (Ref # 130)	130T0845	1
GASKET,CRANKCASE COVER (Ref # 11060)	11060-2122	1
BAFFLE (Ref # 18020)	18020-2060	1
COVER-CRANKCASE (Ref # 49015)	49015-6099	1
CRANKCASE-COMP (Ref # 49120)	49120-6062	1
STUD,6X14 (Ref # 92004)	92004-2083	1
SCREW (Ref # 92009)	92009-2308	1
PIN,DOWEL,10X14 (Ref # 92043)	92043-1037	1
PIN,6.2X8X14 (Ref # 92043A)	92043-1263	1
BEARING-BALL,6306JRCM (Ref # 92045)	92045-2168	1
SEAL-OIL,VC-6X10X2.5 (Ref # 92049)	92049-2097	1
SEAL-OIL (Ref # 92049A)	92049-2199	1
SEAL-OIL (Ref # 92049B)	92049-2220	1