

2010 KX™ 250F PARTS DIAGRAM

Fenders

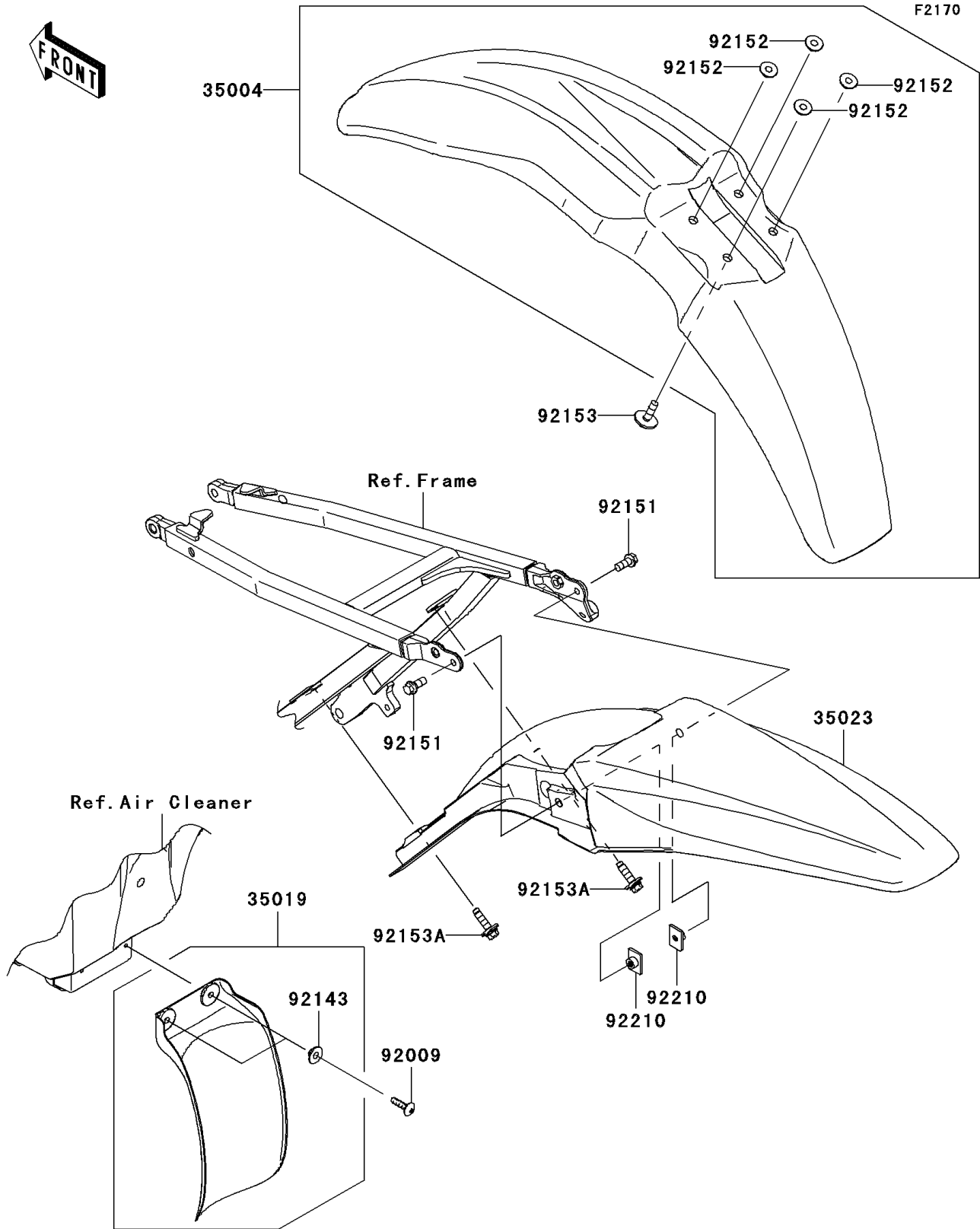

2010 KX™ 250F PARTS LIST

Fenders

ITEM NAME	PART NUMBER	QUANTITY
-----------	-------------	----------