

# 2011 VULCAN® 1700 CLASSIC PARTS DIAGRAM

Fuel Pump

E1520

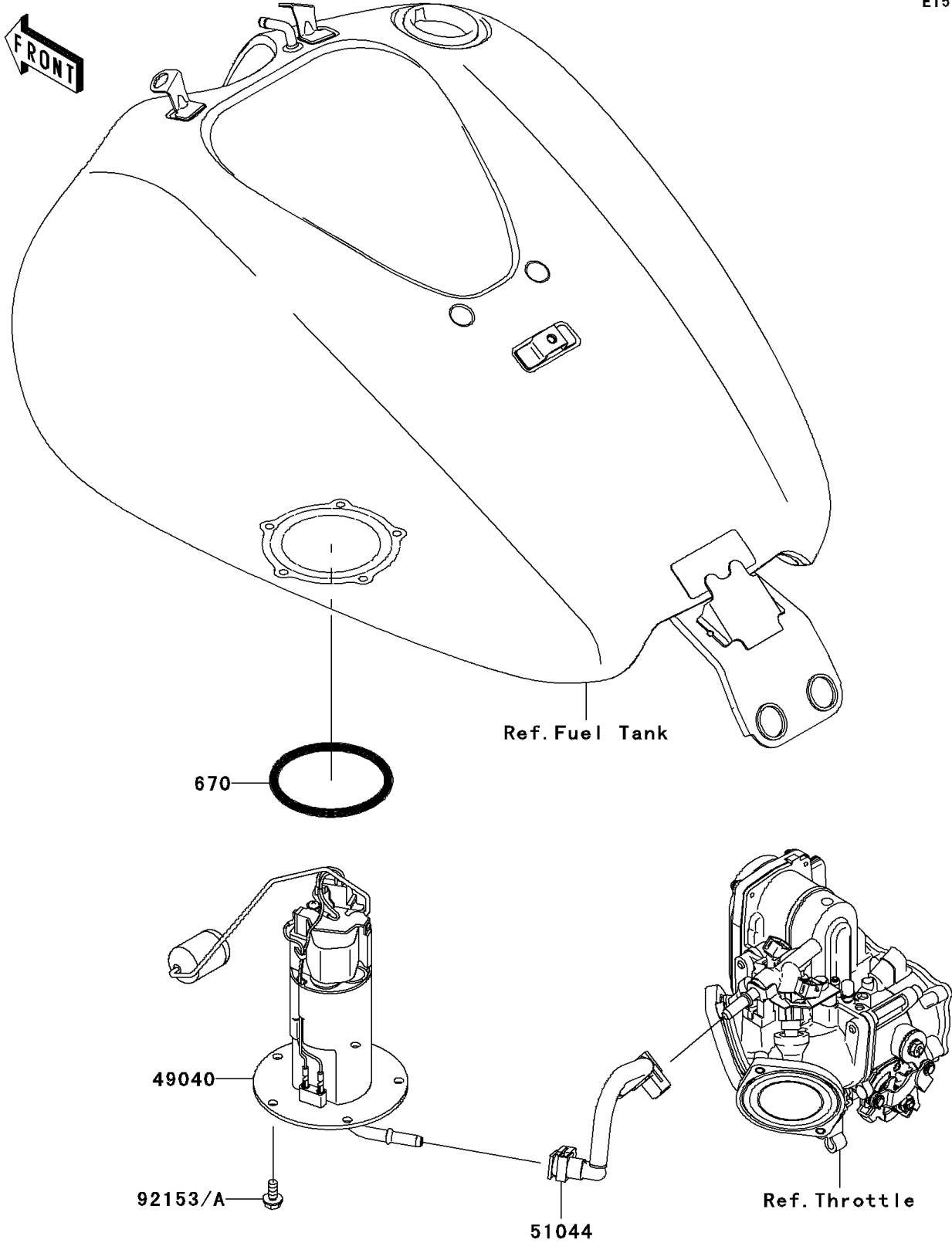

## 2011 VULCAN® 1700 CLASSIC PARTS LIST

### Fuel Pump

ITEM NAME	PART NUMBER	QUANTITY
O RING (Ref # 670)	670E5075	1
PUMP-FUEL (Ref # 49040)	49040-0035	1
TUBE-ASSY,FUEL (Ref # 51044)	51044-0055	1
BOLT,FLANGED,6X12 (Ref # 92153)	92153-1283	5