

2011 VULCAN® 1700 CLASSIC PARTS DIAGRAM

Cylinder Head Cover

E1112

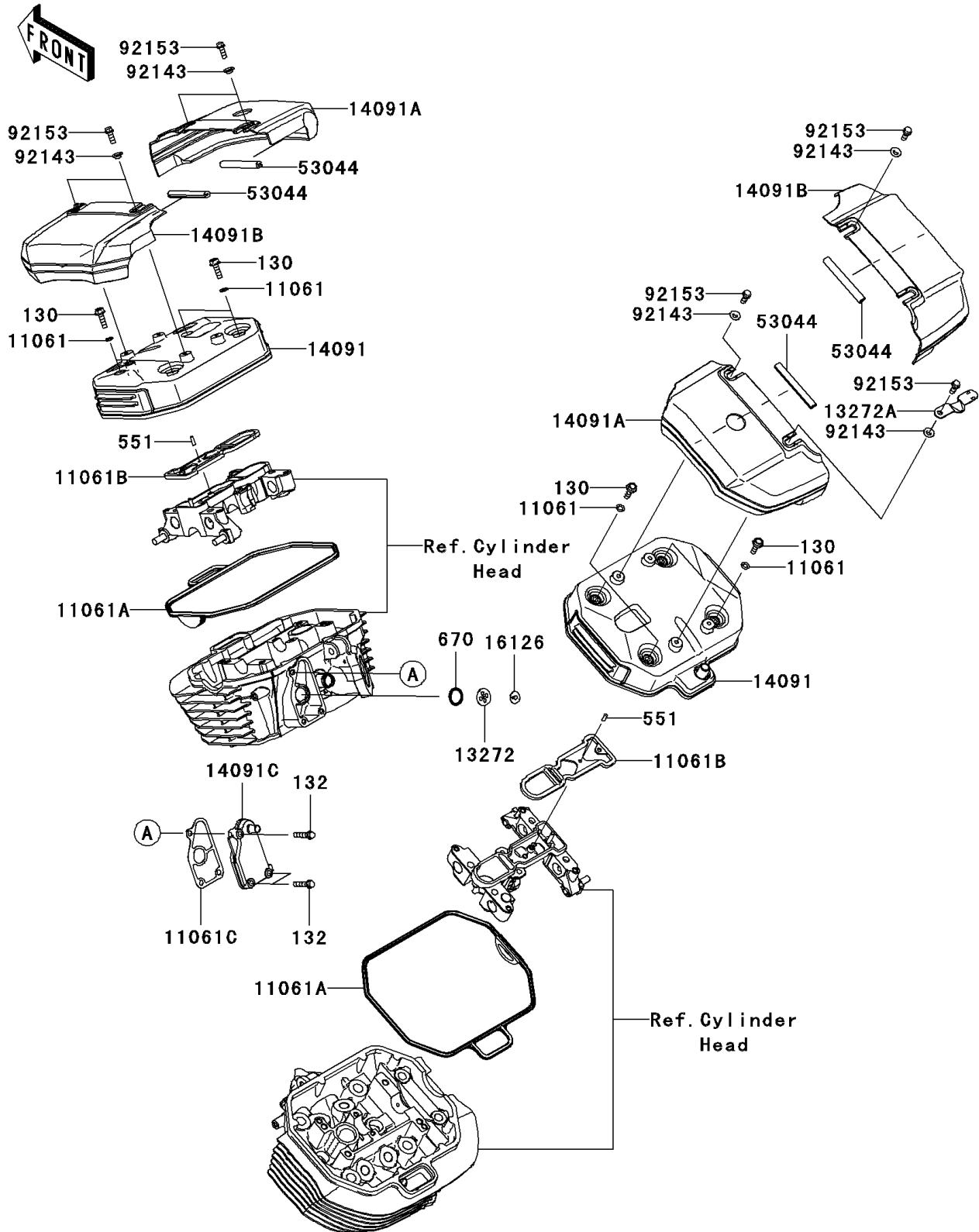

2011 VULCAN® 1700 CLASSIC PARTS LIST

Cylinder Head Cover

ITEM NAME	PART NUMBER	QUANTITY
BOLT-FLANGED,6X20 (Ref # 130)	130BA0620	1
BOLT-FLANGED-SMALL,6X30 (Ref # 132)	132BC0630	1
PIN-DOWEL (Ref # 551)	551A0412	1
O RING (Ref # 670)	670D2018	1
GASKET (Ref # 11061)	11061-0107	1
GASKET,HEAD COVER (Ref # 11061A)	11061-0331	1
GASKET,ROCKER CASE COVER (Ref # 11061B)	11061-0332	1
GASKET,BREATHER COVER (Ref # 11061C)	11061-0334	1
PLATE (Ref # 13272)	13272-0307	1
PLATE (Ref # 13272A)	13272-0711	1
COVER,HEAD,INSIDE (Ref # 14091)	14091-0966	1
COVER,HEAD,OUTSIDE (Ref # 14091A)	14091-0967	1
COVER,HEAD,OUTSIDE (Ref # 14091B)	14091-0968	1
COVER,BREATHER (Ref # 14091C)	14091-0969	1
VALVE (Ref # 16126)	16126-2051	1
TRIM,L=75 (Ref # 53044)	53044-0009	1
COLLAR (Ref # 92143)	92143-1331	1
BOLT,6X16 (Ref # 92153)	92153-0825	1