

## 2014 NINJA® ZX™-10R PARTS DIAGRAM

Stand(s)

F2190

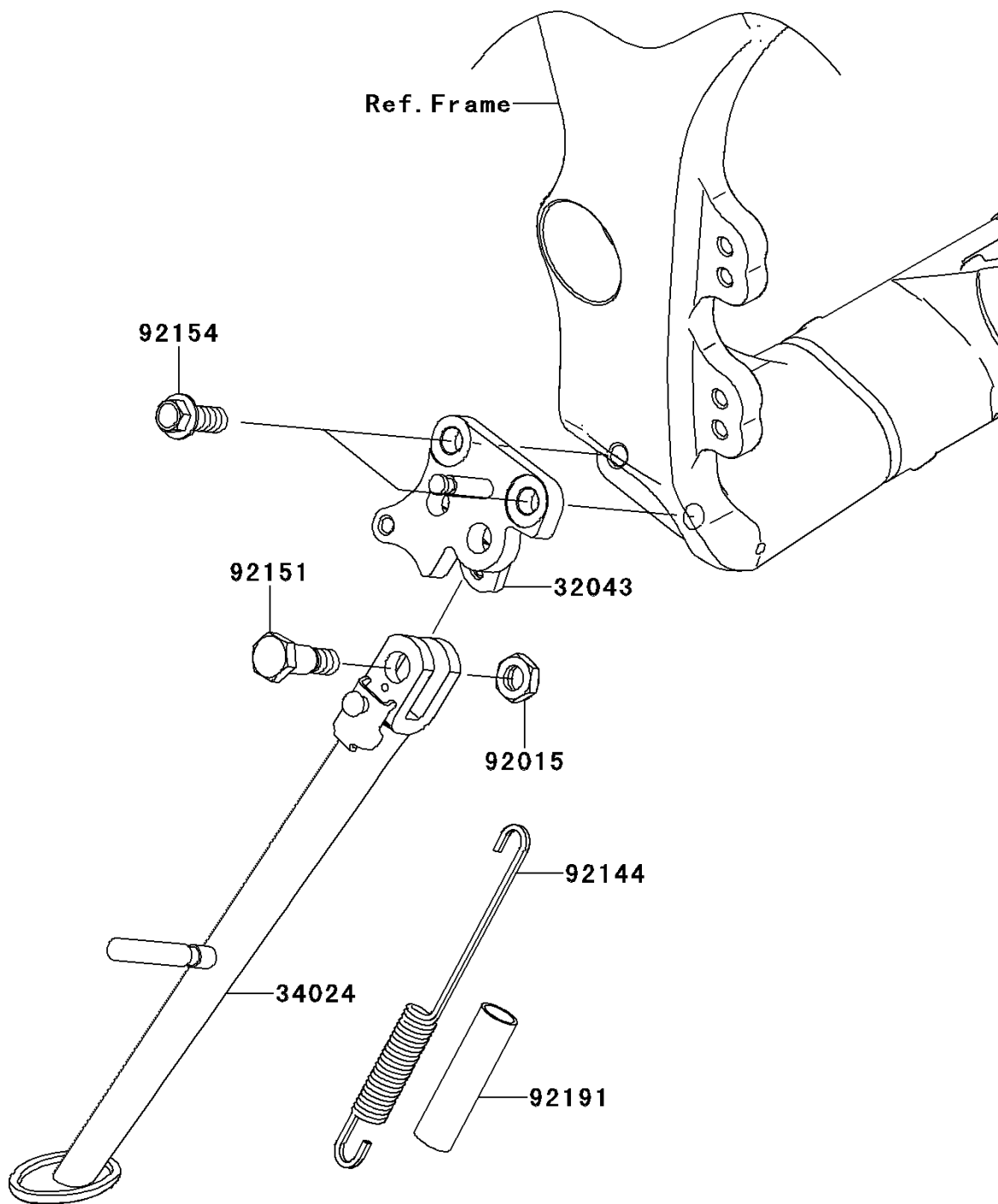

## 2014 NINJA® ZX™-10R PARTS LIST

Stand(s)

ITEM NAME	PART NUMBER	QUANTITY
BRACKET-STAND,F.S.BLACK (Ref # 32043)	32043-0090-18R	1
STAND-SIDE,F.S.BLACK (Ref # 34024)	34024-0093-18R	1
NUT,LOCK,10MM,BLACK (Ref # 92015)	92015-1188	1
SPRING,SIDE STAND (Ref # 92144)	92144-1818	1
BOLT,SIDE STAND (Ref # 92151)	92151-1797	1
BOLT,FLANGED,10X30 (Ref # 92154)	92154-0543	1
TUBE,13X16X60 (Ref # 92191)	92191-1001	1