

2015 VULCAN® 900 CLASSIC LT PARTS DIAGRAM

Brake Pedal/Torque Link

F2260

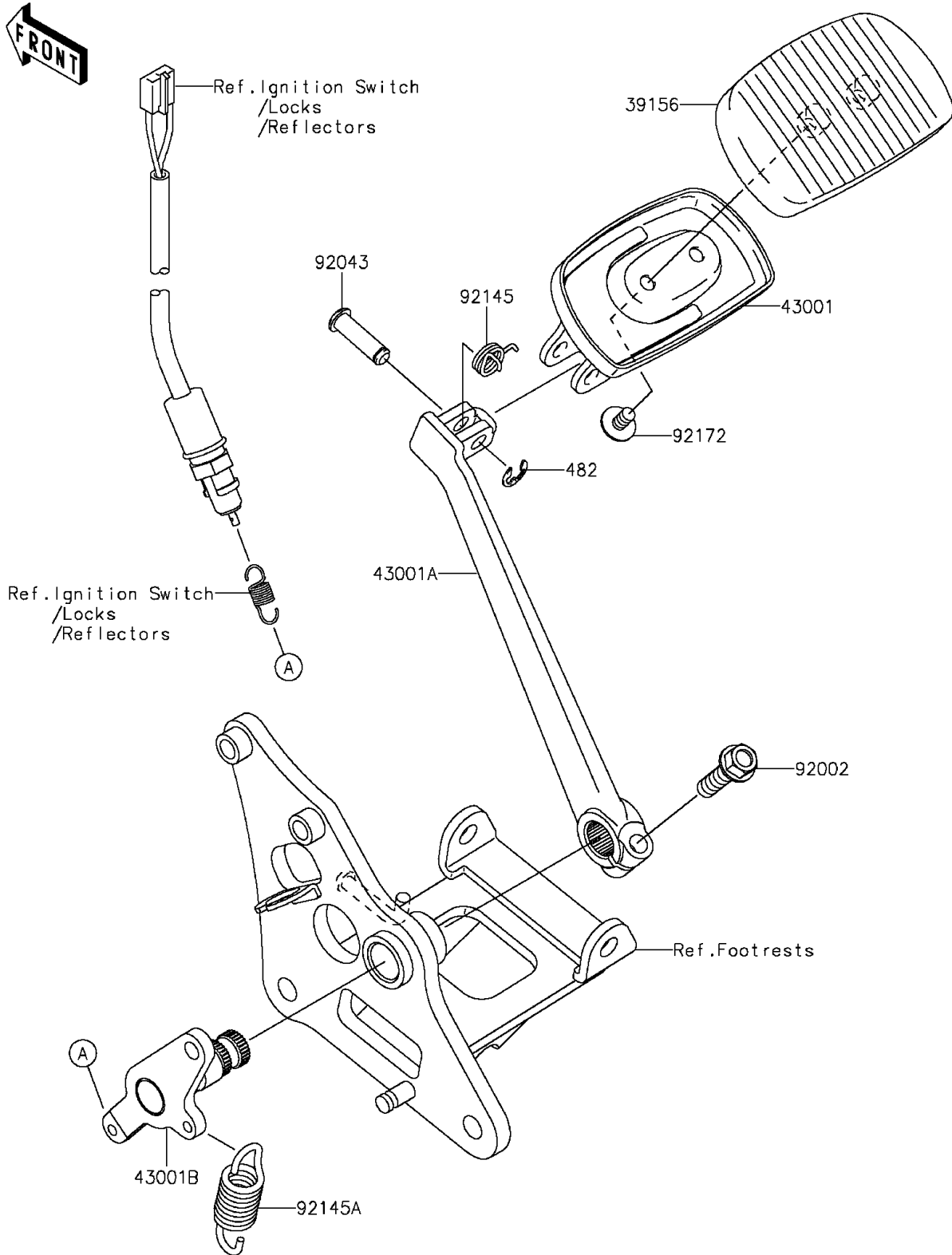

2015 VULCAN® 900 CLASSIC LT PARTS LIST

Brake Pedal/Torque Link

ITEM NAME	PART NUMBER	QUANTITY
-----------	-------------	----------