

2009 Vulcan® 1700 Nomad™ PARTS DIAGRAM

Guard(s)

F2680

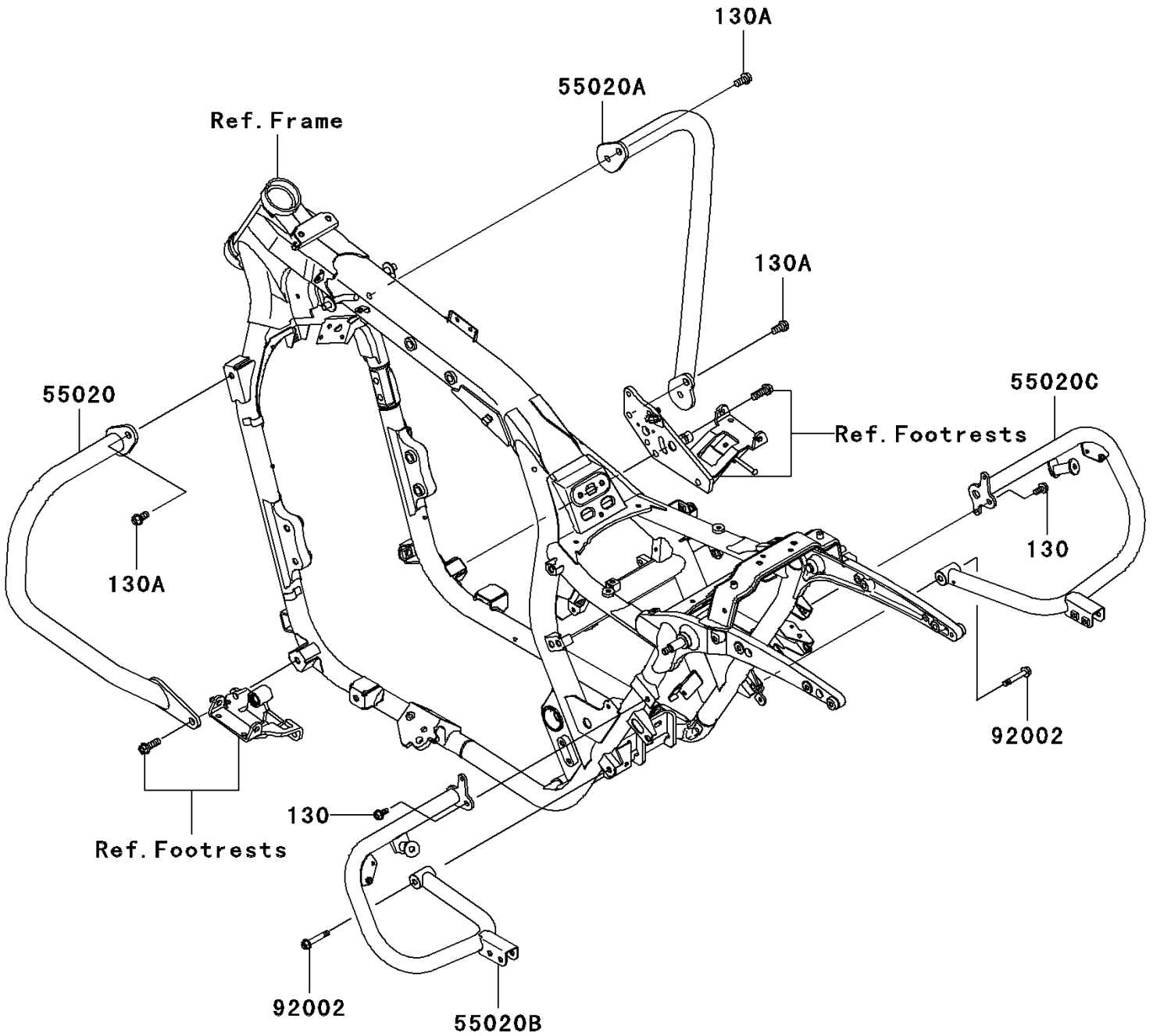

2009 Vulcan® 1700 Nomad™ PARTS LIST

Guard(s)

ITEM NAME	PART NUMBER	QUANTITY
BOLT-FLANGED,8X16 (Ref # 130)	130BA0816	2
BOLT-FLANGED,10X20 (Ref # 130A)	130BC1020	3
GUARD,FR,LH (Ref # 55020)	55020-0525	1
GUARD,FR,RH (Ref # 55020A)	55020-0533	1
GUARD,RR,LH (Ref # 55020B)	55020-0537	1
GUARD,RR,RH (Ref # 55020C)	55020-0538	1
BOLT,FLANGED,8X47 (Ref # 92002)	92002-1850	2