

2008 Vulcan® 900 Classic LT PARTS DIAGRAM

Taillight(s)(JKAVN2D1 7A011497-)

F2720A

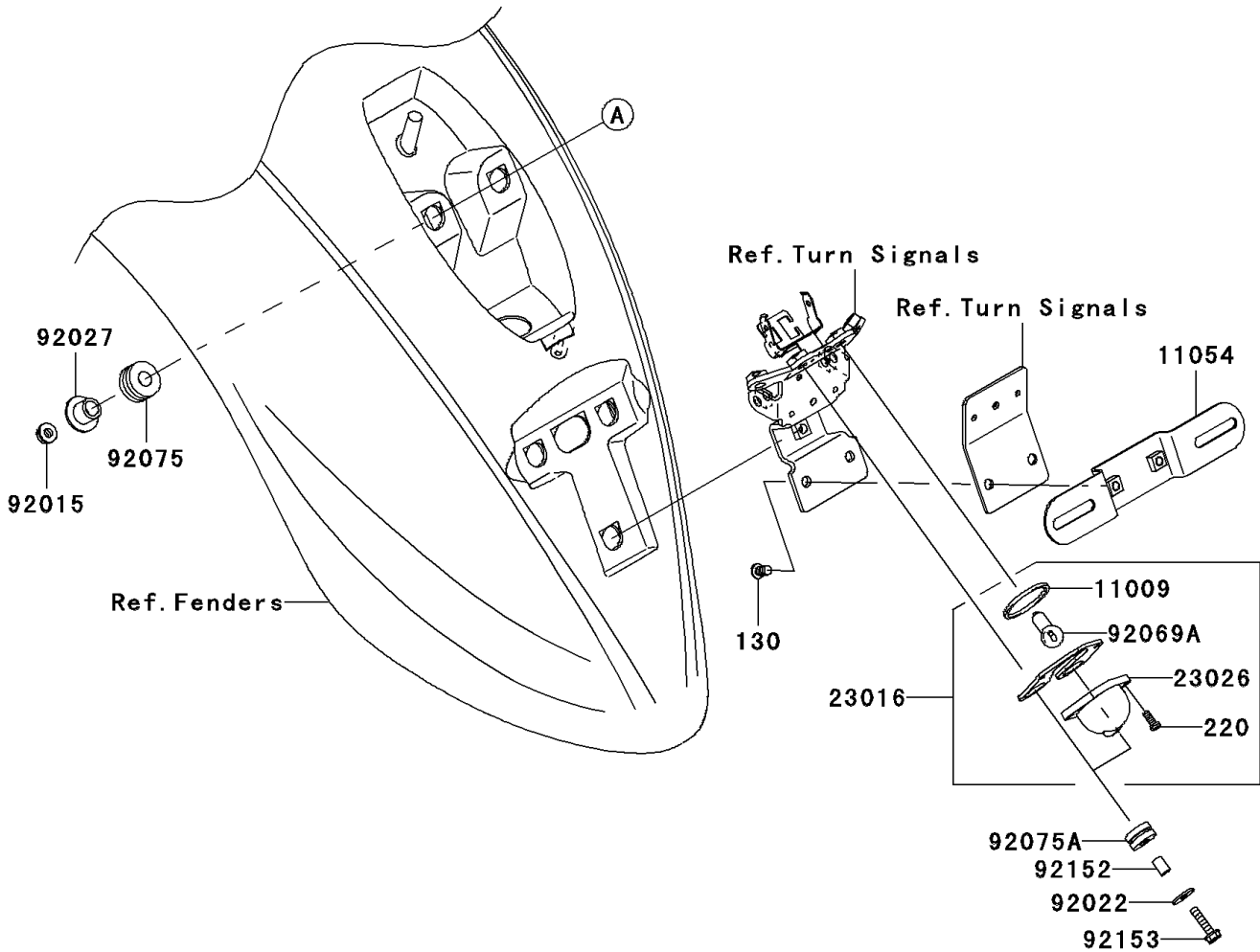
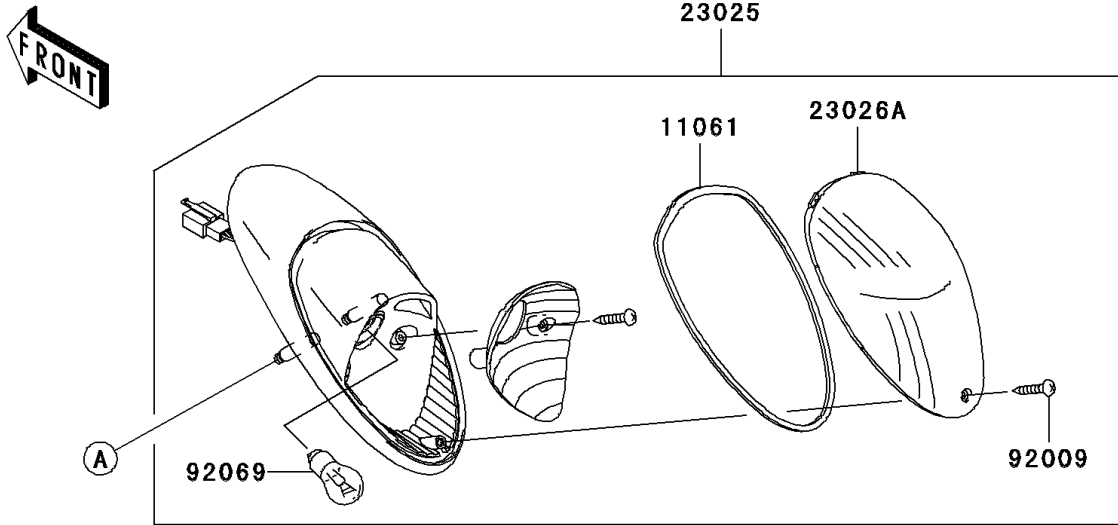

2008 Vulcan® 900 Classic LT PARTS LIST

Taillight(s)(JKAVN2D1 7A011497-)

ITEM NAME	PART NUMBER	QUANTITY
BOLT-FLANGED,6X14 (Ref # 130)	130BB0614	2
SCREW-PAN-CROS,4X10 (Ref # 220)	220AA0410	2
GASKET,LICENSE PLATE LAMP (Ref # 11009)	11009-1372	1
BRACKET,LICENSE (Ref # 11054)	11054-1761	1
GASKET,TAIL LAMP LENS (Ref # 11061)	11061-1089	1
LAMP-ASSY,LICENSE (Ref # 23016)	23016-0007	1
LAMP-TAIL (Ref # 23025)	23025-0025	1
LENS,LAMP (Ref # 23026)	23026-1054	1
LENS,TAIL LAMP (Ref # 23026A)	23026-1246	1
SCREW,TAPPING,4X16 (Ref # 92009)	92009-1966	1
NUT,FLANGED,6MM (Ref # 92015)	92015-1367	2
WASHER,6.5X20X1.6 (Ref # 92022)	92022-1557	2
COLLAR,L=13.1,BLACK (Ref # 92027)	92027-1450	2
BULB,12V 21/5W (Ref # 92069)	92069-063	1
BULB,12V 5W (Ref # 92069A)	92069-1055	1
DAMPER (Ref # 92075)	92075-1690	2
DAMPER (Ref # 92075A)	92075-209	2
COLLAR,6.8X10X13 (Ref # 92152)	92152-0580	2
BOLT,FLANGED,6X25 (Ref # 92153)	92153-0514	2