

2008 Vulcan® 900 Classic LT PARTS DIAGRAM

Oil Pump

E1712

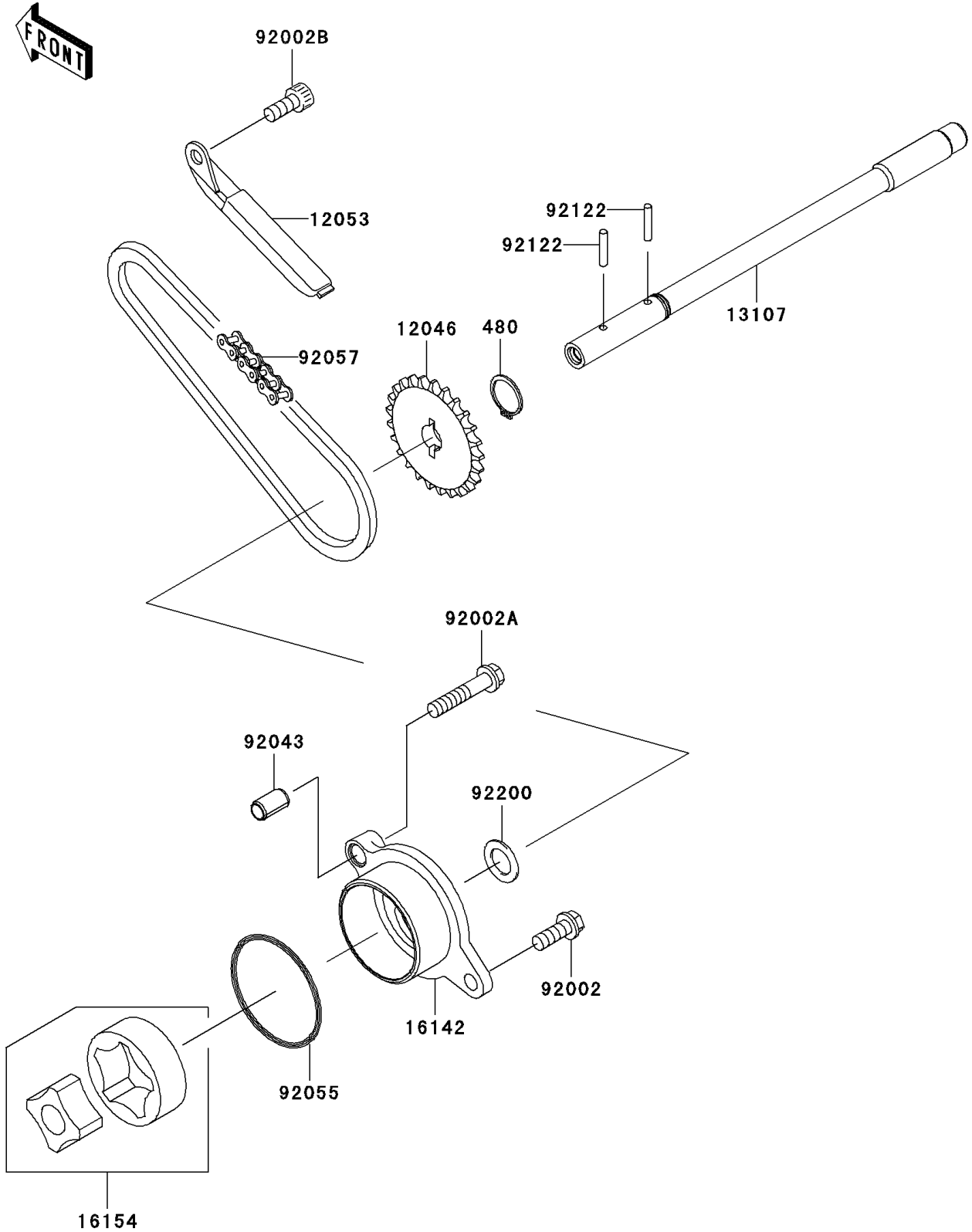

2008 Vulcan® 900 Classic LT PARTS LIST

Oil Pump

ITEM NAME	PART NUMBER	QUANTITY
CIRCLIP-TYPE-C,11MM (Ref # 480)	480J1100	1
SPROCKET,24T (Ref # 12046)	12046-0045	1
GUIDE-CHAIN (Ref # 12053)	12053-0070	1
SHAFT (Ref # 13107)	13107-0116	1
COVER-PUMP,OIL (Ref # 16142)	16142-0028	1
ROTOR-PUMP,40.56X18 (Ref # 16154)	16154-1056	1
BOLT,6X16 (Ref # 92002)	92002-1439	1
BOLT,6X30 (Ref # 92002A)	92002-1534	1
BOLT,SOCKET,6X14 (Ref # 92002B)	92002-1592	1
PIN,6.2X8X14 (Ref # 92043)	92043-1263	1
RING-O,44.7X2.4 (Ref # 92055)	92055-1279	1
CHAIN,DID 25H,54LE (Ref # 92057)	92057-0113	1
ROLLER,3X15.8 (Ref # 92122)	92122-1126	2
WASHER (Ref # 92200)	92200-1009	1