

2009 Eliminator® 125 PARTS DIAGRAM

Engine Mount

F2122

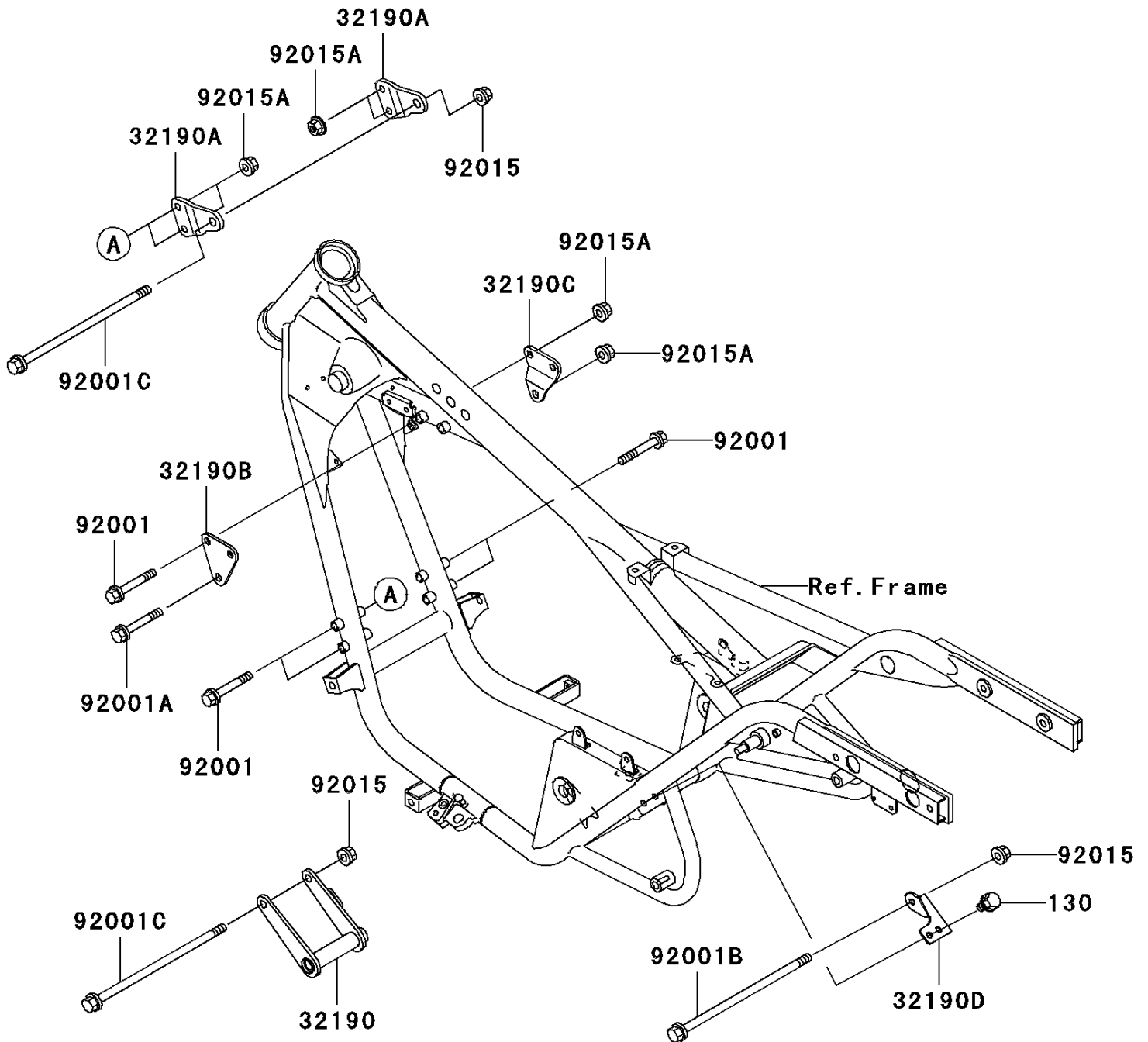

2009 Eliminator® 125 PARTS LIST

Engine Mount

ITEM NAME	PART NUMBER	QUANTITY
BOLT-FLANGED,8X20 (Ref # 130)	130BB0820	1
BRACKET-ENGINE,RR (Ref # 32190)	32190-1092	1
BRACKET-ENGINE,FR (Ref # 32190A)	32190-1093	1
BRACKET-ENGINE,HEAD,LH (Ref # 32190B)	32190-1103	1
BRACKET-ENGINE,HEAD,RH (Ref # 32190C)	32190-1104	1
BRACKET-ENGINE (Ref # 32190D)	32190-1109	1
BOLT,FLANGED,8X65,BLACK (Ref # 92001)	92001-1616	1
BOLT,FLANGED,8X55,BLACK (Ref # 92001A)	92001-1641	1
BOLT,FLANGED,10X110 (Ref # 92001B)	92001-1719	1
BOLT,FLANGED,10X115,BLACK (Ref # 92001C)	92001-1780	1
NUT,FLANGED,10MM (Ref # 92015)	92015-1180	1
NUT,FLANGED,8MM,BLACK (Ref # 92015A)	92015-1251	1