

2009 Eliminator® 125 PARTS DIAGRAM

Camshaft(s)/Tensioner

E1230

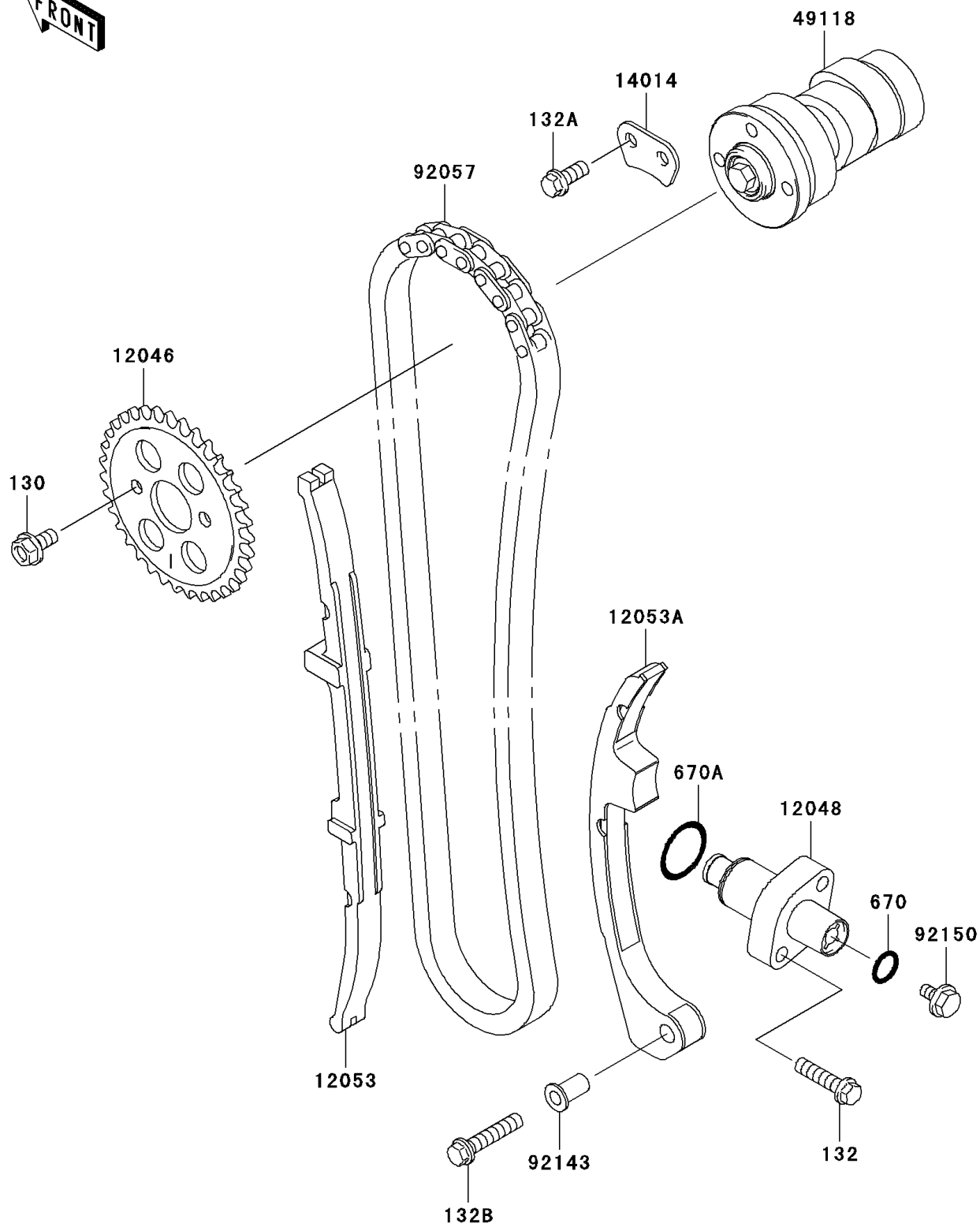

2009 Eliminator® 125 PARTS LIST

Camshaft(s)/Tensioner

ITEM NAME	PART NUMBER	QUANTITY
BOLT-FLANGED,6X12 (Ref # 130)	130CB0612	1
BOLT-FLANGED-SMALL,6X25 (Ref # 132)	132BA0625	1
BOLT-FLANGED-SMALL,6X14 (Ref # 132A)	132BD0614	1
BOLT-FLANGED-SMALL,6X30 (Ref # 132B)	132BD0630	1
O RING (Ref # 670)	670D2010	1
O RING,21MM (Ref # 670A)	670D2021	1
SPROCKET (Ref # 12046)	12046-1192	1
TENSIONER-ASSY (Ref # 12048)	12048-1169	1
GUIDE-CHAIN,FR (Ref # 12053)	12053-1383	1
GUIDE-CHAIN,RR (Ref # 12053A)	12053-1421	1
PLATE-POSITION (Ref # 14014)	14014-1095	1
CAMSHAFT-COMP (Ref # 49118)	49118-1200	1
CHAIN,CAM,92RH2010-102M (Ref # 92057)	92057-1457	1
COLLAR (Ref # 92143)	92143-1857	1
BOLT,TENSIONER (Ref # 92150)	92150-1381	1