

2014 KLR™650 PARTS DIAGRAM

Gear Change Mechanism

E1370

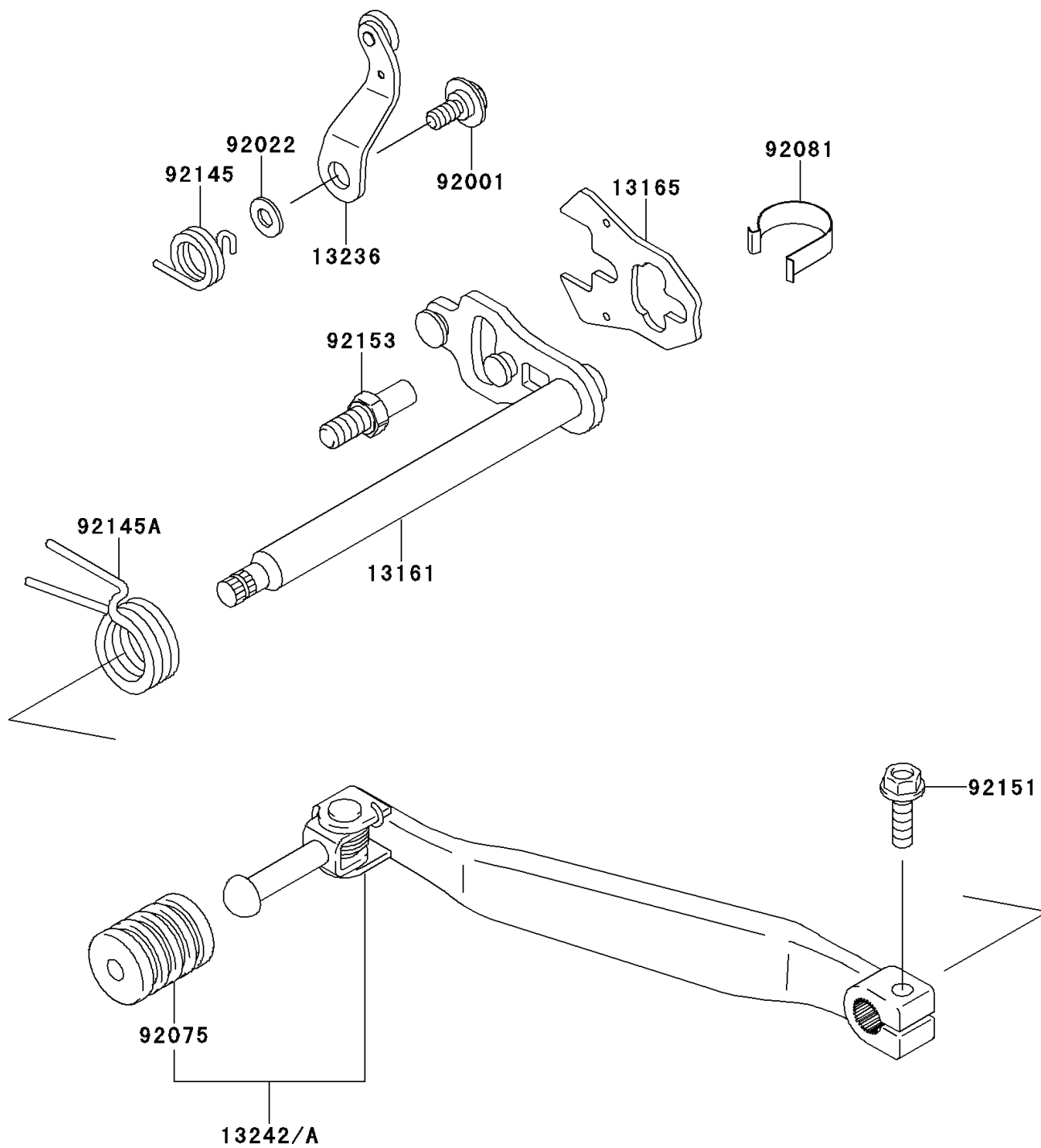

2014 KLR™650 PARTS LIST

Gear Change Mechanism

ITEM NAME	PART NUMBER	QUANTITY
LEVER-COMP-CHANGE SHAFT (Ref # 13161)	13161-0065	1
PAWL (Ref # 13165)	13165-1120	1
LEVER-COMP (Ref # 13236)	13236-0200	1
LEVER-ASSY-CHANGE (Ref # 13242A)	13242-0080	1
BOLT,FLANGED,6X14 (Ref # 92001)	92001-1715	1
WASHER,6X12.8X1.2 (Ref # 92022)	92022-1827	1
DAMPER,CHANGE PEDAL (Ref # 92075)	92075-1944	1
SPRING,CHANGE LEVER (Ref # 92081)	92081-1493	1
SPRING (Ref # 92145)	92145-0773	1
SPRING,CHANGE PEDAL RETURN (Ref # 92145A)	92145-0774	1
BOLT,6X20 (Ref # 92151)	92151-1450	1
BOLT,8X15.5 (Ref # 92153)	92153-0720	1