

2014 KLR™650 PARTS DIAGRAM

Cylinder Head

E1111

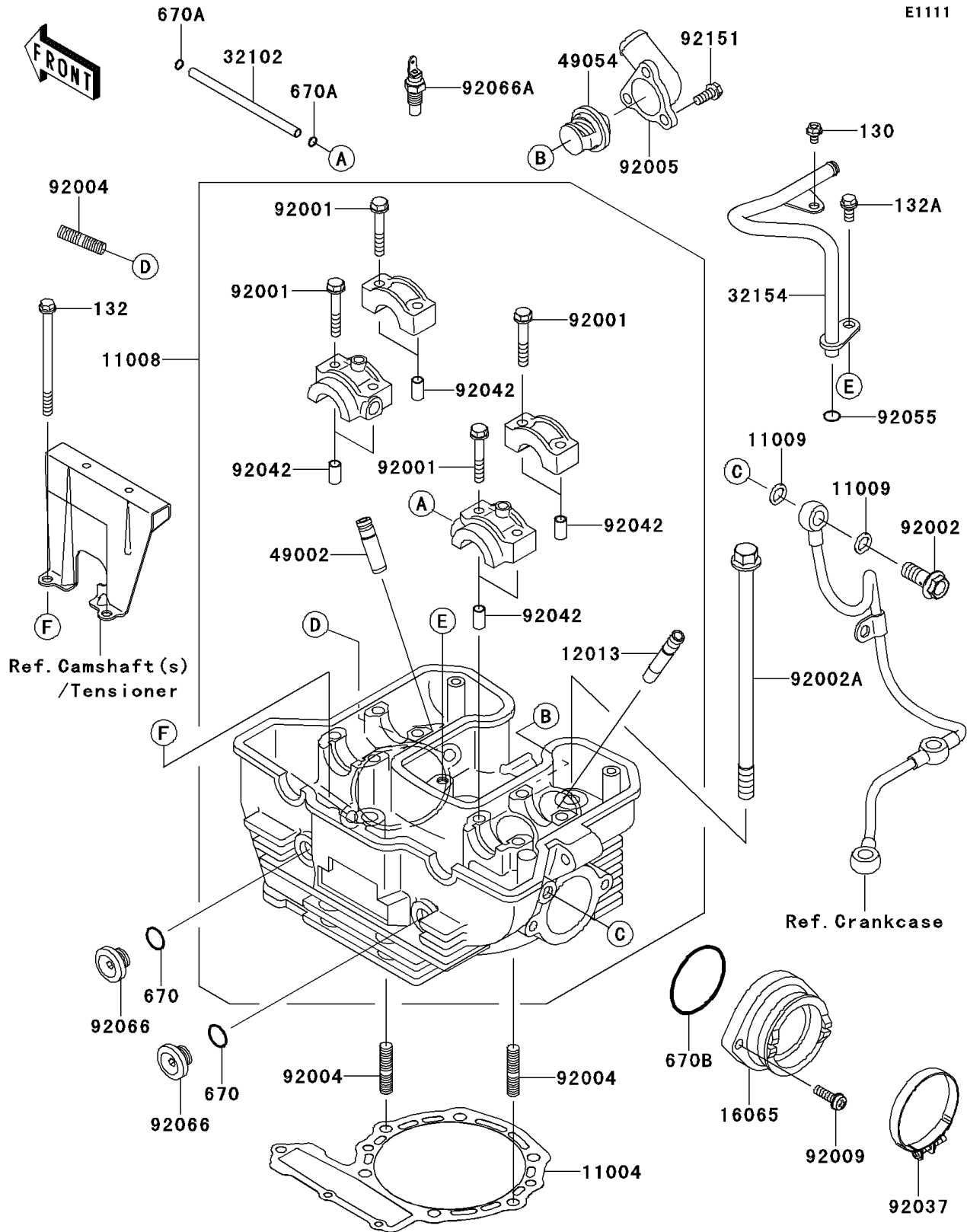

2014 KLR™650 PARTS LIST

Cylinder Head

ITEM NAME	PART NUMBER	QUANTITY
BOLT-FLANGED,5X8 (Ref # 130)	130BD0508	1
BOLT-FLANGED-SMALL,6X85 (Ref # 132)	132BA0685	1
BOLT-FLANGED-SMALL,6X12 (Ref # 132A)	132BD0612	1
O RING,15MM (Ref # 670)	670B2015	1
O RING,6MM (Ref # 670A)	670D1506	1
O RING,48MM (Ref # 670B)	670D3048	1
GASKET-HEAD (Ref # 11004)	11004-1158	1
HEAD-COMP-CYLINDER (Ref # 11008)	11008-0202	1
GASKET,10X14.5X1.5 (Ref # 11009)	11009-1105	1
GUIDE-VALVE,INTAKE (Ref # 12013)	12013-009	1
HOLDER-CARBURETOR (Ref # 16065)	16065-1151	1
PIPE,OIL LINE (Ref # 32102)	32102-1352	1
PIPE (Ref # 32154)	32154-1555	1
GUIDE-VALVE,EXHAUST (Ref # 49002)	49002-1002	1
THERMOSTAT (Ref # 49054)	49054-1053	1
BOLT,FLANGED,6X38 (Ref # 92001)	92001-1105	1
BOLT,BANJO,10X25 (Ref # 92002)	92002-1170	1
BOLT,10X191 (Ref # 92002A)	92002-1874	1
STUD,8X22 (Ref # 92004)	92004-1217	1
FITTING (Ref # 92005)	92005-0715	1
SCREW,6X20 (Ref # 92009)	92009-1325	1
CLAMP,55MM (Ref # 92037)	92037-1486	1
PIN,DOWEL,6.3X8X14 (Ref # 92042)	92042-007	1
RING-O,10MM (Ref # 92055)	92055-1149	1
PLUG (Ref # 92066)	92066-1158	1
PLUG,SENSOR WATER (Ref # 92066A)	92066-1183	1
BOLT,6X14 (Ref # 92151)	92151-1810	1