

# 2006 KFX700 PARTS DIAGRAM

Drive Converter

E1391

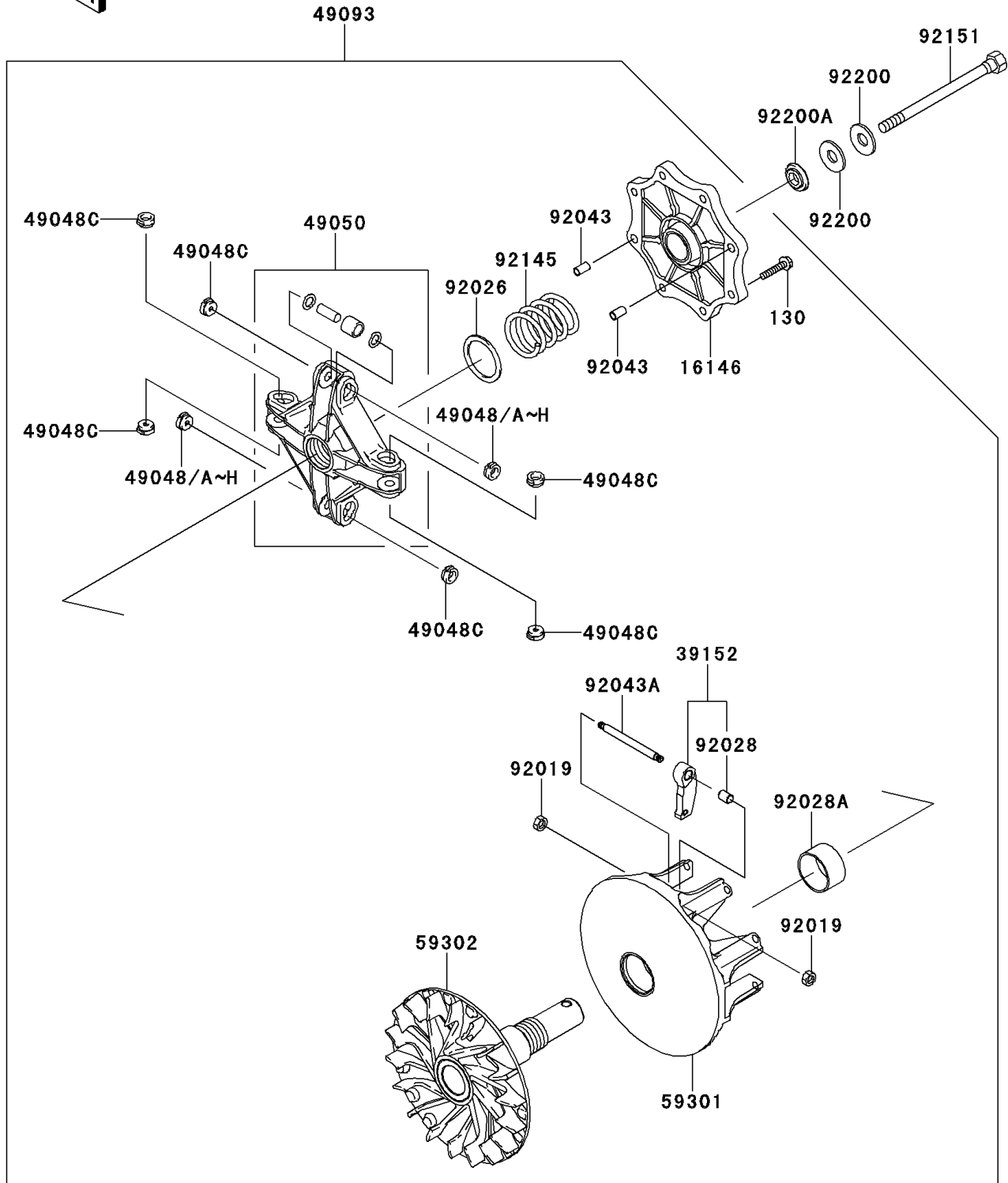

## 2006 KFX700 PARTS LIST

### Drive Converter

ITEM NAME	PART NUMBER	QUANTITY
BOLT-FLANGED,6X30 (Ref # 130)	130CA0630	8
COVER-ASSY (Ref # 16146)	16146-1231	1
WEIGHT-RAMP (Ref # 39152)	39152-1088	4
SHOE,T=7.2 (Ref # 49048)	49048-1087	AR
SHOE,T=7.3 (Ref # 49048A)	49048-1088	AR
SHOE,T=7.4 (Ref # 49048B)	49048-1089	AR
SHOE,T=7.5 (Ref # 49048C)	49048-1090	8
SHOE,T=7.6 (Ref # 49048D)	49048-1091	AR
SHOE,T=7.7 (Ref # 49048E)	49048-1092	AR
SHOE,T=7.8 (Ref # 49048F)	49048-1093	AR
SHOE,T=7.9 (Ref # 49048G)	49048-1094	AR
SHOE,T=8.0 (Ref # 49048H)	49048-1095	AR
SPIDER (Ref # 49050)	49050-1081	1
CONVERTER-ASSY-DRIVE (Ref # 49093)	49093-0010	1
SHEAVE-MOVABLE (Ref # 59301)	59301-1070	1
SHEAVE-COMP (Ref # 59302)	59302-0003	1
NUT,LOCK,6MM (Ref # 92019)	92019-008	8
SPACER,39X49.5X1.0 (Ref # 92026)	92026-1603	1
BUSHING (Ref # 92028)	92028-1973	4
BUSHING (Ref # 92028A)	92028-1975	1
PIN,6.2X8X14 (Ref # 92043)	92043-1263	2
PIN (Ref # 92043A)	92043-1688	4
SPRING (Ref # 92145)	92145-0021	1
BOLT,12X165 (Ref # 92151)	92151-1393	1
WASHER,SPRING (Ref # 92200)	92200-1504	2
WASHER (Ref # 92200A)	92200-1634	1