

1990 Ninja® ZX™-6 PARTS DIAGRAM

Seat

F2510

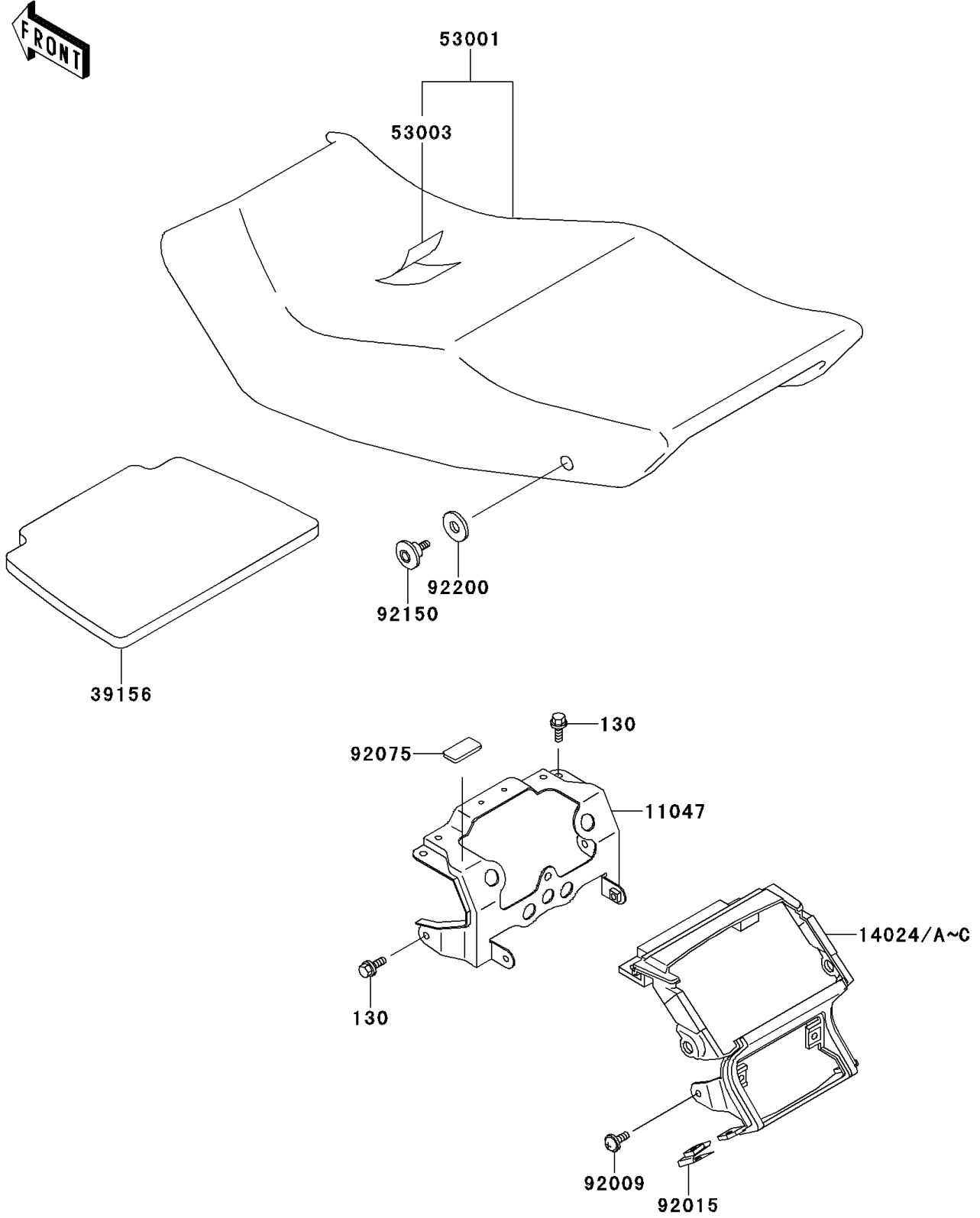

1990 Ninja® ZX™-6 PARTS LIST

Seat

ITEM NAME	PART NUMBER	QUANTITY
BOLT-FLANGED (Ref # 130)	130J0612	4
BRACKET,TAIL (Ref # 11047)	11046-1950	1
PAD,SEAT (Ref # 39156)	39156-1214	1
SEAT-ASSY,DUAL,BLACK (Ref # 53001)	53001-1601-MA	1
LEATHER,SEAT,BLACK (Ref # 53003)	53003-1237-MA	1
SCREW,6X14 (Ref # 92009)	92009-1288	2
NUT,5MM (Ref # 92015)	92015-1798	2
DAMPER (Ref # 92075)	92075-1883	2
BOLT,SOCKET,6MM (Ref # 92150)	92150-1154	2
WASHER (Ref # 92200)	92200-1013	2
COVER,TAIL,M.S.BLUE (Ref # 14024)	14024-1897-GW	1
COVER,TAIL,ROSE OPERA (Ref # 14024A)	14024-1897-HC	1
COVER,TAIL,M.S.BLUE (Ref # 14024B)	14024-1897-HM	1
COVER,TAIL,ROSE OPERA (Ref # 14024C)	14024-1897-HS	1