

1990 Ninja® ZX™ -6 PARTS DIAGRAM

Crankcase

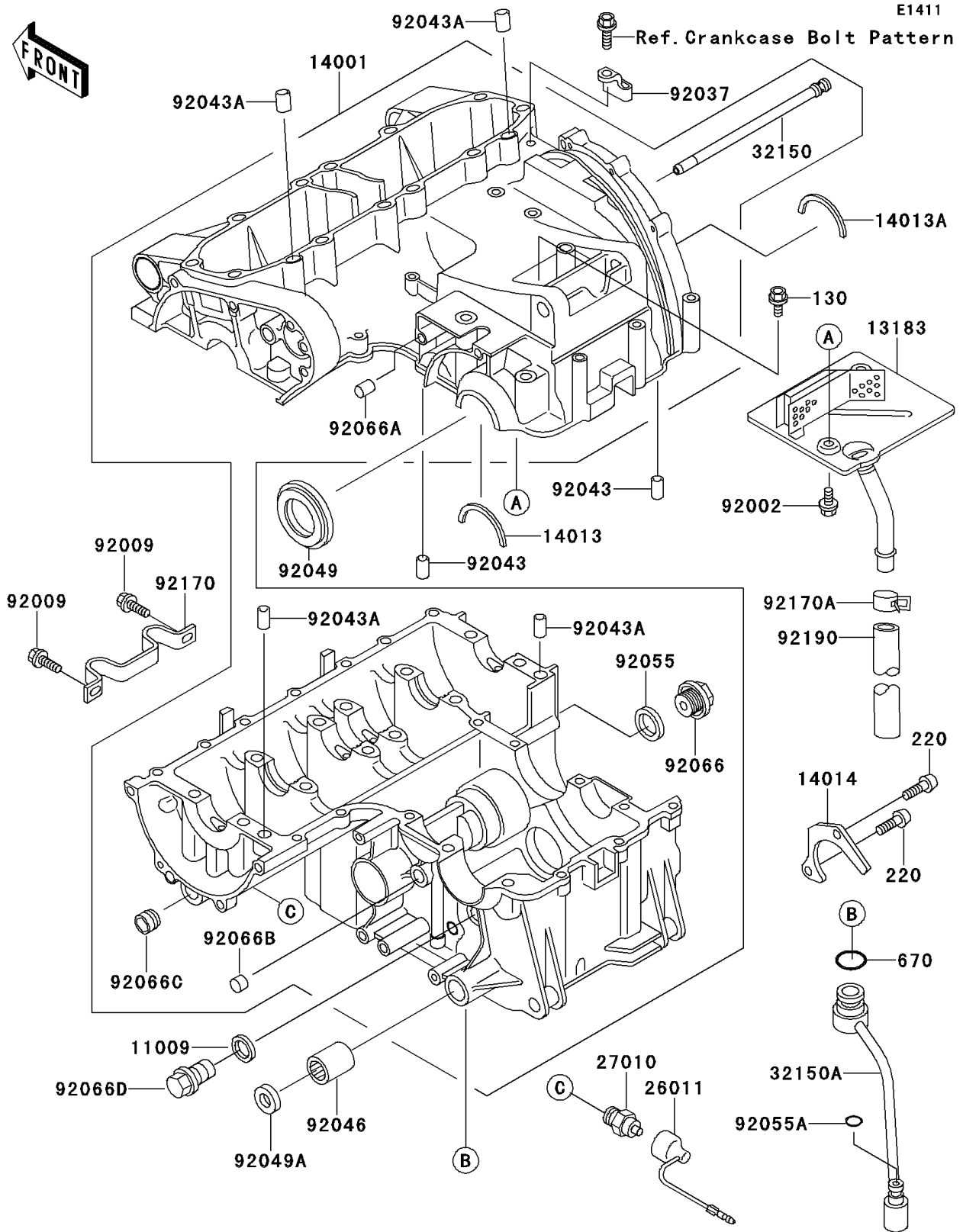

1990 Ninja® ZX™-6 PARTS LIST

Crankcase

ITEM NAME	PART NUMBER	QUANTITY
BOLT-FLANGED,6X10 (Ref # 130)	130B0610	1
SCREW-PAN-CROS,6X14 (Ref # 220)	220B0614	2
O RING,14MM (Ref # 670)	670B2014	1
GASKET,14.3X20X1 (Ref # 11009)	11009-1238	1
PLATE,BREATHER (Ref # 13183)	13183-1531	1
SET-CRANKCASE (Ref # 14001)	14001-5281	1
RING-POSITION (Ref # 14013)	14013-004	1
RING-POSITION,T=1.98 (Ref # 14013A)	14013-1004	1
PLATE-POSITION (Ref # 14014)	14014-1102	1
WIRE-LEAD (Ref # 26011)	26011-1371	1
SWITCH,OIL PRESSURE (Ref # 27010)	27010-1155	1
PIPE,OIL (Ref # 32150)	32150-1619	1
PIPE,OIL (Ref # 32150A)	32150-1620	1
BOLT,6X10 (Ref # 92002)	92002-1449	2
SCREW,TAPPING,5X8 (Ref # 92009)	92009-1603	2
CLAMP (Ref # 92037)	92037-1724	1
PIN,DOWEL,6X16 (Ref # 92043)	92042-016	2
PIN,8.2X10X14 (Ref # 92043A)	92043-1264	4
BEARING-NEEDLE,HK1312 (Ref # 92046)	92046-1148	1
SEAL-OIL,TC32528 (Ref # 92049)	92049-1307	1
SEAL-OIL,TB13225.5 (Ref # 92049A)	92051-005	1
RING-O (Ref # 92055)	92055-1146	1
RING-O,5.5X1.5 (Ref # 92055A)	92055-1343	1
PLUG,18X9 (Ref # 92066)	92066-066	1
PLUG (Ref # 92066A)	92066-1012	1
PLUG (Ref # 92066B)	92066-1110	1
PLUG (Ref # 92066C)	92066-1252	1
PLUG,14X8 (Ref # 92066D)	92066-1273	1
CLAMP (Ref # 92170)	92170-1159	1

1990 Ninja® ZX™-6 PARTS LIST

Crankcase

ITEM NAME	PART NUMBER	QUANTITY
CLAMP (Ref # 92170A)	92170-2043	1
TUBE,L=127 (Ref # 92190)	92190-1107	1