

2019 MULE PRO-MX™ EPS CAMO PARTS DIAGRAM

Crankcase

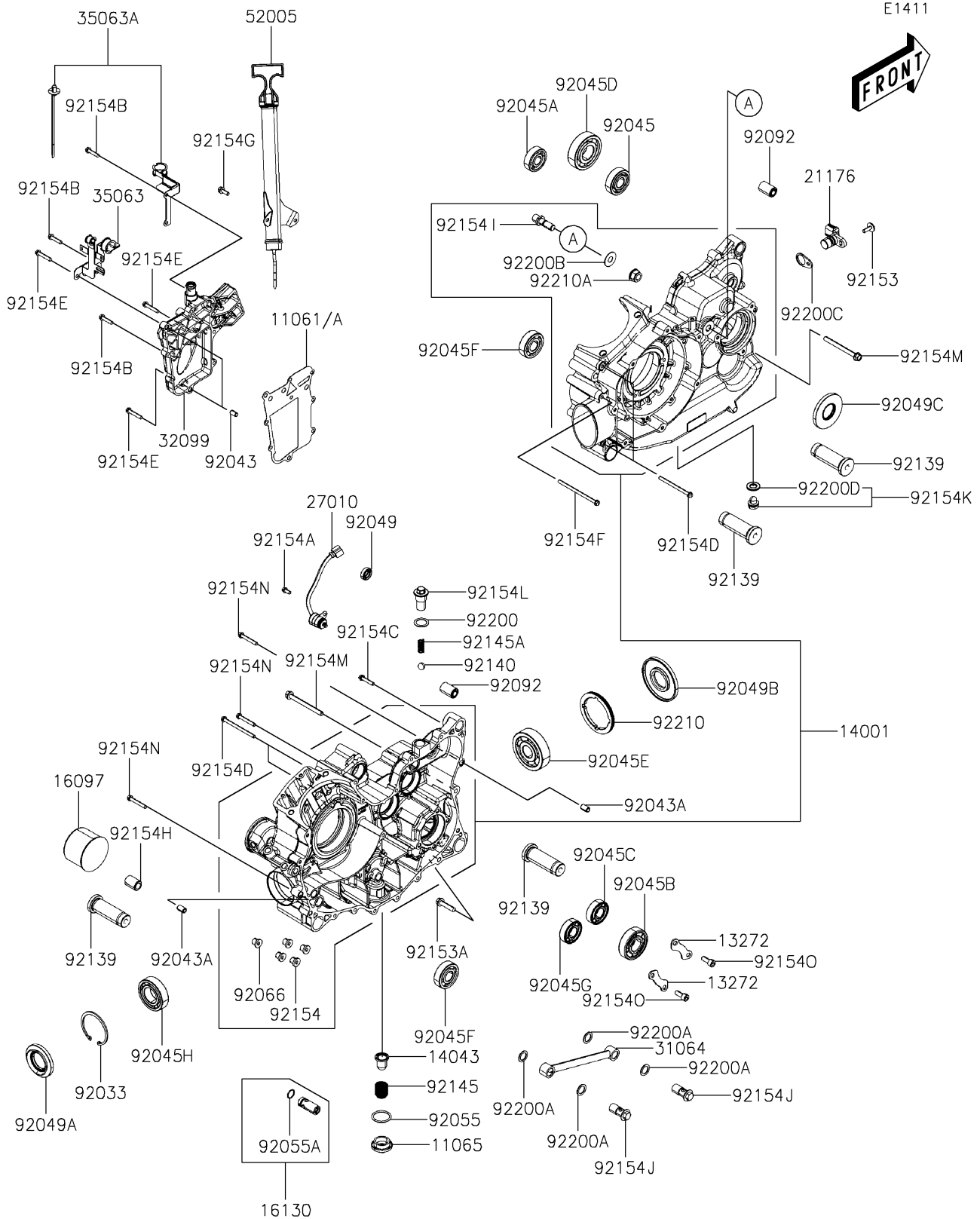

2019 MULE PRO-MX™ EPS CAMO PARTS LIST

Crankcase

ITEM NAME	PART NUMBER	QUANTITY
GASKET,CASE,RH (Ref # 11061)	11061-Y061	1
CAP (Ref # 11065)	11065-Y006	1
PLATE (Ref # 13272)	13272-Y035	2
SET-CRANKCASE (Ref # 14001)	14001-Y004	1
FILTER,OIL (Ref # 14043)	14043-Y001	1
FILTER-ASSY-OIL (Ref # 16097)	16097-0007	1
VALVE-ASSY-RELIEF (Ref # 16130)	16130-Y001	1
SENSOR,SPEED (Ref # 21176)	21176-Y010	1
SWITCH,GEAR CHANGE (Ref # 27010)	27010-Y019	1
PIPE-COMP,OIL (Ref # 31064)	31064-Y008	1
CASE,RH (Ref # 32099)	32099-Y007	1
STAY,START MOTOR CABLE (Ref # 35063)	35063-Y035	1
STAY,HARNESS (Ref # 35063A)	35063-Y037	1
GAUGE,OIL LEVEL ASSY (Ref # 52005)	52005-Y005	1
RING-SNAP (Ref # 92033)	92033-Y038	1
PIN,8X14 (Ref # 92043)	92043-Y012	2
PIN,10X16 (Ref # 92043A)	92043-Y024	2
BEARING-BALL,6304 (Ref # 92045)	92045-Y016	1
BEARING-BALL,6303 (Ref # 92045A)	92045-Y023	1
BEARING-BALL,6305 (Ref # 92045B)	92045-Y040	1
BEARING-BALL,6204 (Ref # 92045C)	92045-Y041	1
BEARING-BALL,6306 (Ref # 92045D)	92045-Y042	1
BEARING-BALL,6405 (Ref # 92045E)	92045-Y043	1
BEARING-BALL,6304 (Ref # 92045F)	92045-Y045	2
BEARING-BALL (Ref # 92045G)	92045-Y048	1
BEARING-BALL (Ref # 92045H)	92045-Y049	1
SEAL-OIL,14X24X7 (Ref # 92049)	92049-Y044	1
SEAL-OIL,35X67X7 (Ref # 92049A)	92049-Y045	1
SEAL-OIL,35X90X7 (Ref # 92049B)	92049-Y046	1

2019 MULE PRO-MX™ EPS CAMO PARTS LIST

Crankcase

ITEM NAME	PART NUMBER	QUANTITY
SEAL-OIL,30X72X7 (Ref # 92049C)	92049-Y048	1
RING-O,30.8MM (Ref # 92055)	92055-Y005	1
RING-O,15.5X1.5 (Ref # 92055A)	92055-Y038	1
PLUG (Ref # 92066)	92066-Y019	1
BUSHING-RUBBER (Ref # 92092)	92092-Y003	2
BUSHING,ENGINE HANGER (Ref # 92139)	92139-Y012	4
BALL,STEEL 16 (Ref # 92140)	92140-Y002	1
SPRING (Ref # 92145)	92145-Y005	1
SPRING,STOPPER (Ref # 92145A)	92145-Y068	1
BOLT,6X20 (Ref # 92153)	92153-Y019	1
BOLT,FLANGE,8X35 (Ref # 92153A)	92153-Y034	1
BOLT,SEALING,12MM (Ref # 92154)	92154-Y009	4
BOLT,FLANGE,6X12 (Ref # 92154A)	92154-Y035	1
BOLT,FLANGE,6X25 (Ref # 92154B)	92154-Y066	6
BOLT,FLANGE,6X30 (Ref # 92154C)	92154-Y107	10
BOLT,FLANGE,6X80 (Ref # 92154D)	92154-Y109	4
BOLT,FLANGE,6X32 (Ref # 92154E)	92154-Y128	3
BOLT,FLANGE,6X100 (Ref # 92154F)	92154-Y144	1
BOLT,FLANGE,6X18 (Ref # 92154G)	92154-Y154	2
BOLT,OIL FILTER (Ref # 92154H)	92154-Y165	1
BOLT (Ref # 92154I)	92154-Y167	1
BOLT,OIL PASS (Ref # 92154J)	92154-Y174	2
BOLT,DRAIN (Ref # 92154K)	92154-Y187	1
BOLT (Ref # 92154L)	92154-Y188	1
BOLT,FLANGE,8X85 (Ref # 92154M)	92154-Y196	2
BOLT,FLANGE,6X40 (Ref # 92154N)	92154-Y209	3
BOLT,SOCKET,8X20 (Ref # 92154O)	92154-Y210	4
WASHER (Ref # 92200)	92200-Y071	1
WASHER (Ref # 92200A)	92200-Y074	4

2019 MULE PRO-MX™ EPS CAMO PARTS LIST

Crankcase

ITEM NAME	PART NUMBER	QUANTITY
WASHER,THRUST,12X30X1 (Ref # 92200B)	92200-Y075	1
WASHER,SPEED SENSOR (Ref # 92200C)	92200-Y086	1
WASHER (Ref # 92200D)	92200-Y099	1
NUT,LOCK,85MM (Ref # 92210)	92210-Y086	1
NUT,FLANGE,12MM (Ref # 92210A)	92210-Y091	1